



Breas Vivo 45 User Manual

006149 F-1 en-EU

Vivo 45 User Manual



Vivo 45, User's
ENGLISH (EU)

CE 2797 UK CA 0086



Breas Medical AB, Företagsvägen 1, SE-435 33 Mölnlycke, Sweden
Phone +46 31 86 88 00
Order +46 31 86 88 20, Technical Support +46 31 86 88 60
Fax +46 31 86 88 10,, www.breas.com, Date: 2023-10-17 | 24564

Table of Contents

1	Introduction	7
1.1	What is the Vivo 45?	7
1.2	Intended Use	8
1.3	Contraindications	8
1.4	Intended Environment	9
1.5	Operation by Lay Users	9
1.6	About this Manual	10
1.6.1	Audience	10
1.6.2	Icons in this Manual	10
1.7	Manufacturer Information	11
2	Safety Information	12
2.1	General User Precautions	12
2.2	Electrical Safety	14
2.3	Environmental Conditions	15
2.4	Usage of Patient Circuit	16
2.5	Usage of Filters	18
2.6	Humidification	18
2.7	Cleaning and Maintenance	19
2.8	Usage of Oxygen	20
3	Product Description	22
3.1	Main Components	22
3.2	Front View	24
3.3	Side Views	25
3.3.1	Detaching and Reattaching the Side Panels	26
3.4	Equipment Designation	28
3.4.1	Additional Symbols	29
4	Preparing the Vivo 45 for Use	31
4.1	Checking the Vivo 45 before First Use	31
4.2	Placing the Vivo 45	31
4.3	Connecting the Vivo 45 to Mains	33
4.4	Connecting the Patient Circuit	34
4.5	Inspecting the Vivo 45 before Use	35
4.6	Adjusting the Vivo 45 Patient Settings	36
4.7	Performing the Pre-use Test	36
4.7.1	Actions At Pre-Use Test Failure	37
5	How to Use the Vivo 45	39
5.1	Switch the Vivo 45 On and Off	39
5.2	Using the Menu	41
5.2.1	Navigating with the Buttons	41
5.2.2	Symbols Used in the Menu	42

5.2.3	Menu Overview	44
5.2.4	Display Overview	45
5.2.5	The Main Display, Home Mode	46
5.2.6	The Setup Section, Home Mode	47
5.2.7	The Alarm Section	48
5.2.8	The Monitor Section	49
5.2.9	The Others Section	49
5.3	Monitored Values in the Vivo 45	50
5.3.1	Ppeak	51
5.3.2	PEEP	51
5.3.3	Pmean	51
5.3.4	Leakage	51
5.3.5	MVe	52
5.3.6	MVi	52
5.3.7	Vte	52
5.3.8	Vti	52
5.3.9	FiO ₂	52
5.3.10	% in TgV	52
5.3.11	Total Rate	52
5.3.12	Spont Rate	52
5.3.13	% Spont	52
5.3.14	SpO ₂ (Oxygen Saturation)	53
5.3.15	Pulse Rate	53
5.3.16	I:E	53
5.3.17	Insp. Time	53
5.3.18	Rise Time	53
5.3.19	EtCO ₂	53
5.3.20	InspCO ₂	53
5.3.21	PtcCO ₂	53
5.4	Modes in the Vivo 45	53
5.4.1	Standby and Operating Mode	54
5.4.2	Device Mode	54
5.4.3	Patient Mode	54
5.4.4	Ventilation and Breath Modes	54
5.5	Functions and Parameters in the Vivo 45	56
5.5.1	Parameters' Availability in Different Modes	57
5.5.2	Insp. Pressure	59
5.5.3	PEEP	59
5.5.4	Breath Rate	59
5.5.5	Backup Rate	59
5.5.6	Insp. Time (Inspiratory Time)	59

5.5.7	Backup Insp. Time (Backup Inspiratory Time).....	60
5.5.8	Rise Time	60
5.5.9	Insp. Trigger (Inspiratory Trigger)	60
5.5.10	Exp. Trigger (Expiratory Trigger)	60
5.5.11	Max Insp. Time (Maximum Inspiratory Time).....	61
5.5.12	Min Insp. Time (Minimum Inspiratory Time)	61
5.5.13	Target Volume	61
5.5.14	CPAP.....	62
5.5.15	Ramp Time	62
5.5.16	Start Pressure	62
5.5.17	Always Start Ramp.....	62
5.5.18	Humidifier	63
5.5.19	Humidifier Setting	63
5.5.20	Heated Circuit Temp	63
5.5.21	Circuit Heating.....	63
5.6	Using Batteries	63
5.6.1	Power Source Priority	63
5.6.2	Power Switchover Tests	64
5.6.3	Charging the Batteries	64
5.6.4	Battery Icons	65
5.6.5	Internal Battery	66
5.6.6	Click-in Battery	66
5.6.7	Battery Operating Time (Internal and Click-in)	67
5.6.8	Storing the Internal Battery and the Click-in Battery	67
5.6.9	External DC.....	68
5.7	Using Accessories.....	69
5.7.1	Connecting and Disconnecting the Cables	69
5.7.2	Using the ventilator with a Nurse Call System.....	69
5.7.3	Using the ventilator with the FiO ₂ Sensor.....	70
5.7.4	Using the ventilator with the Remote Alarm	71
5.7.5	Using the ventilator with the EtCO ₂ Sensor.....	71
5.7.6	Using the ventilator with the PtcCO ₂ Cable.....	75
5.7.7	Using the Ventilator with the SpO ₂ module	75
5.7.8	Using the Ventilator with the Effort Belts	75
5.7.9	Using the ventilator with the Remote Start/Stop.....	76
5.7.10	Using the ventilator with the Protective Cover.....	77
5.7.11	Using the Vivo 45 with the Trolley	77
5.7.12	Using the Click-in Humidifier	78
5.7.13	Using the Patient Circuit with Heated Wire	83
6	Alarms	85
6.1	Alarm Function.....	85

6.1.1	Alarm Indication	85
6.1.2	Audible Signal Pause	86
6.1.3	Audible Signal Presilence.....	86
6.1.4	Alarm Reset	87
6.2	Operator's Position.....	87
6.3	Physiological Alarms	87
6.3.1	High Pressure Alarm	88
6.3.2	Low Pressure Alarm	89
6.3.3	High PEEP Alarm.....	90
6.3.4	Low PEEP Alarm	90
6.3.5	High V_t (High Inspired Tidal Volume Alarm)	91
6.3.6	Low V_t Alarm (Low Inspired Tidal Volume).....	91
6.3.7	High MV_i Alarm (High Inspired Minute Volume Alarm).....	92
6.3.8	Low MV_i (Low Inspired Minute Volume Alarm)	92
6.3.9	High V_{t_e} Alarm (High Expired Tidal Volume)	93
6.3.10	Low V_{t_e} Alarm (Low Expired Tidal Volume).....	93
6.3.11	High MV_e (High Expired Minute Volume Alarm).....	94
6.3.12	Low MV_e Alarm (Low Expired Minute Volume)	94
6.3.13	High Breath Rate Alarm.....	95
6.3.14	Low Breath Rate Alarm	96
6.3.15	Apnea Alarm.....	97
6.3.16	Disconnection Alarm	97
6.3.17	Rebreathing Alarm	98
6.3.18	Obstruction Alarm	99
6.3.19	High FiO_2 Alarm	99
6.3.20	Low FiO_2 Alarm.....	100
6.3.21	High SpO_2 Alarm	100
6.3.22	Low SpO_2 Alarm.....	101
6.3.23	High $EtCO_2$ Alarm	101
6.3.24	Low $EtCO_2$ Alarm.....	102
6.3.25	High $InspCO_2$ Alarm (High Inspired CO_2).....	102
6.3.26	High Pulse Rate Alarm.....	103
6.3.27	Low Pulse Rate Alarm	103
6.3.28	$PtcCO_2$ Alarm.....	104
6.4	Technical Alarms	104
6.4.1	Power Fail Alarm	104
6.4.2	High Patient Air Temp. (High Patient Air Temperature)	105
6.4.3	Low Patient Air Temp. (Low Patient Air Temperature Alarm).....	105
6.4.4	Low Last Power Source Alarm	105
6.4.5	Crit. Low Last Power Source Alarm	106
6.4.6	Lost Mains Alarm.....	106

6.4.7	SpO ₂ Disconnected (SpO ₂ Sensor Failure/Disconnection Alarm)	106
6.4.8	SpO ₂ Signal Lost Alarm	107
6.4.9	Poor SpO ₂ Signal	107
6.4.10	CO ₂ Disconnected (CO ₂ Sensor Failure/Disconnection Alarm)	107
6.4.11	CO ₂ Accuracy Error Alarm	108
6.4.12	Check CO ₂ Adapter Alarm	108
6.4.13	CO ₂ Sensor Error Alarm	108
6.4.14	FiO ₂ Disconnected (FiO ₂ Sensor Failure/Disconnection Alarm)	109
6.4.15	Ambient Pressure Compensation Lost Alarm	109
6.4.16	Temperature Comp. Lost (Ambient Temperature Compensation Lost Alarm)	110
6.4.17	Humidity Comp. Lost (Humidity Compensation Lost Alarm)	110
6.4.18	LED Failure Alarm	110
6.4.19	Low Alarm Battery Alarm	111
6.4.20	Alarm Battery Error Alarm	111
6.4.21	Internal/Click-In Battery Hot Alarm	111
6.4.22	Heated Circuit Temp. Alarm	112
6.4.23	High Humidifier Temp. Alarm	112
6.4.24	Humidifier Fault Alarm	113
6.4.25	Heated Circuit Fault Alarm	113
6.4.26	Internal Function Failure	114
6.4.27	Air Temp. Sensor Fail Alarm	114
6.4.28	Internal Error Alarm	114
6.4.29	Database Integrity Fail Alarm	115
6.4.30	Cooling Fan Error Alarm	115
6.4.31	Clock Failure Alarm	115
6.4.32	Internal Temp High Alarm	116
6.4.33	Humidifier/Bypass Loose Alarm	116
6.5	Alarm Test	116
6.5.1	Alarm Signal Test	116
6.5.2	Mandatory Alarm Tests	116
6.5.3	Optional Alarm Tests	118
7	Cleaning and Maintenance	120
7.1	Cleaning the Vivo 45	120
7.1.1	Main Unit	120
7.1.2	Air Pathway Disinfection	121
7.1.3	Patient Circuit	121
7.2	Cleaning and Replacing the Filters	122
7.2.1	Washing a coarse filter	123

7.3	Change of Patients	123
7.4	Regular Maintenance	123
7.5	Service and Repair	123
7.6	Storage	123
7.7	Disposal	123
8	Technical Specifications	125
8.1	System Description	125
8.1.1	Pneumatic Diagram for the ventilator	125
8.2	Data	126
8.2.1	Worst Case Accuracy	126
8.2.2	Modes Specifications	126
8.2.3	Parameter Specifications	126
8.2.4	Monitored Values Specifications	130
8.2.5	Power Supply	131
8.2.6	Environmental Conditions	131
8.2.7	Other	132
8.3	Emission and Immunity Declaration	133
8.3.1	Vivo 45 Essential Performance	133
8.3.2	Guidance and Manufacturer's Declaration – Electromagnetic Immunity	134
8.3.3	Guidance and Manufacturer's Declaration – Electromagnetic Emission	136
8.3.4	Frequencies of portable and mobile transmitters for which the recommended separation distance is 30 cm (12 inches)	136
8.3.5	Recommended separation distances between external power conductors and the ventilator	137
8.4	Delivery Settings	137
9	Accessories and Parts	139
9.1	Patient Circuits and Air Delivery Accessories	139
9.2	Power Accessories	142
9.3	Monitoring Accessories	144
9.4	Ventilator Filters and Detachable Parts	148
9.5	Other Accessories	149
10	Patient Settings	153
11	FAA Compliance	154
	Index	155

Introduction

WARNING!

Risk of Personal Injury

The Vivo 45 must only be used:

- For the intended treatment in accordance with this manual and with the instructions given by the responsible clinical personnel.
- In accordance with the operating conditions specified in this manual.
- In original and unmodified shape and only with compatible accessories.

Every other use may lead to risk of personal injury!



CAUTION!

Read this manual thoroughly so that you completely understand how the Vivo 45 is operated and maintained before taking it into use, to ensure correct usage, maximum performance and serviceability. Non-professional caregivers (e.g. family members) should consult the medical equipment provider's respiratory therapist if they have any questions about the function, proper use, operation, service or maintenance of the Vivo 45.

Breas Medical reserves the right to make changes to this product without any prior notification.

U.S. Federal law restricts this device to sale by or on order of a physician.



1.1

What is the Vivo 45?

The Vivo 45 is a pressure ventilator capable of delivering continuous or intermittent ventilatory support for patients who require invasive or non-invasive mechanical ventilation. The Vivo 45 is capable of running 24 hours/day.

The Vivo 45 can be operated in the following ventilation modes:

- PSV (Pressure Support Ventilation). May be combined with:
 - TgV (Target Volume)
 - AE (Auto-EPAP)
- PCV (Pressure Controlled Ventilation). May be combined with:
 - A (Assist function — inspiration trigger)
 - TgV (Target Volume)
 - AE (Auto-EPAP)
 - MPV (Mouthpiece Ventilation)
- CPAP (Continuous Positive Airway Pressure)

Compatible Patient Circuits

The Vivo 45 should be used with a leakage circuit and a suitable patient interface or an MPV circuit. See 9 *Accessories and Parts*, page 139 for detailed information about compatible patient circuits.

The patient circuit shall comply to ISO 17510. The leakage should be at least 12 l/min at 4 cmH₂O, to prevent rebreathing of exhaled air. The recommended leakage is 20 to 50 l/min at 10 cmH₂O pressure.

Compatible Patient Interfaces

For invasive use, the patient interface may be a tracheostomy tube (cuffed or uncuffed).

For non-invasive use it may be a mask, mouthpiece or pillow interface. See the patient interface's instructions for use when selecting the interface to use.

Data Log

The Vivo 45 has an internal memory with a data log that holds the following data:

- Running hours
- Technical alarms
- Settings
- Asset data
- Treatment hours
- Treatment settings
- Device serial number
- Physiological alarms
- Detailed log, containing at least 24 h data of clinical data (monitored values)
- Breath log, containing at least 30 day data of (monitored values)
- Usage log (containing at least 1 year data of non-clinical events, alarms and settings)

The log data is maintained when device is powered off or in case of power failure. When logs are filled up, the oldest data will be discarded. The data can be transferred to a computer, printed out, and analyzed via Breas software products, see .



For more information about Breas software products, please contact your Breas representative.

Multiple Use

This is a multiple patient multiple use ventilator. If it should be used by multiple patients, see the cleaning instructions in 7.3 *Change of Patients*, page 123 before assigning it to a new patient. Note that accessories to the ventilator might be for single patient use and should in that case be replaced at change of patient.

Expected Service Life

The expected service life of the Vivo 45 is 8 years.

1.2 Intended Use

Vivo 45 is intended to provide non-invasive or invasive ventilation for adult or paediatric patients weighing over 10 kg (22 lbs) who require long-term support or mechanical ventilation for respiratory insufficiency or respiratory failure, with or without obstructive sleep apnea.

Vivo 45 is intended for spontaneously breathing patients.

1.3 Contraindications

The Vivo 45 is not a life-support ventilator and is contraindicated in patients who are unable to tolerate more than brief interruptions in ventilation.

If a patient has any of the following conditions, therapy with positive airway pressure may be contraindicated and the prescribing clinician shall decide if the benefit of ventilatory assistance outweighs the risks:

- Untreated pneumothorax
- Pneumomediastinum
- Inability to maintain a patent airway or adequately clear excessive respiratory secretions
- Severe acute systemic complications (shock, unstable arrhythmias, myocardial ischemia)
- Severe bullous lung disease
- Risk of vomiting
- Pathologically low blood pressure, especially if associated with intravascular volume depletion
- Cerebrospinal fluid leak, recent cranial surgery or trauma

The use of the Vivo 45 is contraindicated in an MRI environment.

Adverse Effects

If the patient experiences chest discomfort, pain, severe headache or shortness of breath while using the Vivo 45, a physician or responsible clinician should be contacted immediately.

The following side effects may occur during the course of therapy with the Vivo 45, patients are advised to report any new or changing adverse effects to their physician:

- Nasal, mouth or throat dryness
- Nosebleeds
- Abdominal bloating
- Ear or sinus discomfort
- Eye irritation
- Skin rashes

1.4 Intended Environment

The Vivo 45 is intended to be used in clinical settings (e.g. hospitals, sub-acute care institutions), public spaces and home environments as well as during portable applications such as wheelchairs, personal family vehicles, ground ambulances and civil aircraft, excluding helicopters.

It is not intended for use during emergency transportation.

1.5 Operation by Lay Users

Day-to-day caregivers, patients, relatives and other non-professional users may operate the Vivo 45 with the *Home mode* activated, after it has been set up according to the prescribed treatment. In Home mode, some settings and controls are locked or hidden.

The lay operator may also perform basic maintenance that doesn't require special equipment or a service environment.

Training

The lay operator shall be trained to basic knowledge of the Vivo 45 and in the specific operations they are assigned to perform. The training shall be based on this user manual and the responsible clinical personnel shall assess the level of training required for each lay operator. This manual shall be available for training and as reference when operating the Vivo 45.

1.6 About this Manual



CAUTION!

Always read this manual before setting up and using the Vivo 45 or performing maintenance on the machine, to ensure correct usage, maximum performance and serviceability.

1.6.1 Audience

This manual is intended for patients and other lay users operating the Vivo 45.





- Care providers, clinical personnel, physicians and others who require a working knowledge of the Vivo 45 will find additional information on settings and functions in the Clinician's Manual. The Clinician's manual should be of the same revision as the User's Manual.
- Service personnel may order the Service Manual that contains detailed technical information for maintenance, service, repair and disposal procedure. The Service manual's revision is independent of the User's Manual revision.

1.6.2 Icons in this Manual

In this manual, icons are used to highlight specific information. The meaning of each icon is explained in the table below.

Icon	Explanation
	Warning! Risk of death or personal injury.
	Warning! Risk of Cross-contamination.
	Warning! Risk of electric shock.
	Warning! Hot surface, risk of burns.
	Warning! Flammable material, risk of fire.
	Caution! Risk of equipment damage, loss of data, extra work, or unexpected results.
	MR Unsafe. The device should not enter a magnetic resonance (MR) environment, such as an MRI scanner room.

Icon	Explanation
	Note Information that may be valuable but is not of critical importance, tips.
	Reference Reference to other manuals with additional information on a specific topic.

1.7 Manufacturer Information

Legal Manufacturer



Postal Address

Breas Medical AB
Företagsvägen 1
SE-435 33 Mölnlycke Sweden

Web Address

www.breas.com

Email address

breas@breas.com

Phone

+46 31 868800, Order: +46 31 868820, Technical support: +46 31 868860

Fax

+46 31 868810

UK Sales and Support Information

UK Responsible Person: Breas Medical Ltd

Phone UK Head Office

+44 (0)1789293460

Fax UK Head Office

+44 (0)1789262470

General Enquiries and Ordering

orders@nippyventilator.com

Tech Support

techsupport@nippyventilator.com

Local Representatives Information

www.breas.com/contact-us/

2 Safety Information

2.1 General User Precautions

WARNING!

Risk of Personal Injury

The Vivo 45 must only be used:

- For the intended treatment in accordance with this manual and with the instructions given by the responsible clinical personnel.
- In accordance with the operating conditions specified in this manual.
- In original and unmodified shape and only with compatible accessories.

Every other use may lead to risk of personal injury!

Risk of Insufficient Ventilation

Usage outside the specified operating conditions may cause reduced performance.

The Vivo 45 must only be used in accordance with the operating conditions specified in this manual.

Risk of Reduced Safety and Performance

Accessories that have not been verified to be compatible with the Vivo 45 might affect safety features and performance negatively.

Only use the Vivo with accessories that are compatible with the ventilator. Use of incompatible parts to connect the ventilator to the patient can result in degraded performance and change of pressure gradient.

Breas Medical has verified the compatibility between the Vivo 45 and the accessories listed in the Clinician's manual.

The responsible organization must ensure the compatibility of the ventilator with all parts used to connect to the patient before starting the intended treatment. If incompatible accessories are used, Breas Medical has no responsibility for the safe and effective use of the Vivo 45.

Changes to the patient circuit, like adding or removing accessories or changing type or length of breathing tube, may affect both circuit compliance and alarm triggering conditions.

It's recommended to perform a pre-use test and re-test the alarm function after making changes to the patient circuit.

When a patient is treated, there must be a supervising person present during the treatment in order to take care of alarms and conditions that the patient cannot solve on their own.

If using the ventilator in a transport case, only use the protective cover specified in the accessory list to prevent adverse ventilator performance, which can consequently result in patient death.

To prevent disconnection of the patient circuit during use, only tubes in compliance with ISO 5367 or ISO 80601-2-74 should be used.

The ventilator may not work properly if any part has been dropped, damaged or submerged in water.

WARNING!

Risk of Burns

Covering breathing tubes with a blanket or heating them with an overhead heater can affect the quality of the therapy or injure the patient.



WARNING!

Risk of Faulty Treatment

If the patient is admitted to a hospital or is prescribed any other form of medical treatment, always inform the medical staff that the patient is on mechanical ventilation treatment.

Risk of Faulty Treatment

Do not use the Vivo 45 in the event of:

- Suspected damage to the device, including the occurrence of Internal Functional Failure alarms.
- Unexpected patient symptoms during treatment.
- Unexplainable or sudden changes of pressure, performance or sound during operation.
- Delivered air being abnormally hot or emitting an odor.

Contact your responsible care provider for an inspection.

Risk of Faulty Treatment

The responsible organization should periodically reassess the settings of the therapy for effectiveness.

Before starting treatment, always perform the procedure 4.5 *Inspecting the Vivo 45 before Use*, page 35.

The ventilator is not suitable for a ventilator dependent patient.

Risk of Unnoticed Critical Conditions

- All the physiological alarms of the Vivo 45 must be set at safe levels that will effectively warn the user of any risk.
The alarm levels should be assessed considering the patient's treatment settings.
- Any change of treatment settings or change of components in the ventilation system may require readjustment of the alarm levels.
- The alarm sound level should be set to a clearly audible level. Setting the alarm sound level below that of the ambient sound level can impede recognition of alarm conditions.

CAUTION!

Clinical personnel must read the Clinician's manual thoroughly and understand the ventilator operation before setting up and using the ventilator.

- Handle the ventilator with care.
- Do not use the ventilator while in the carry bag.
- Do not use the ventilator with nitric oxide, helium or helium mixtures.

Contact Injuries: Skin irritation may occur due to prolonged exposure to either a mask (if used) or the SpO₂ module.

Ensure that the cooling air intake vents are not blocked. If the vents are blocked, especially in hot use environments, the surface temperature of the patient circuit may rise above 41°C (106°F). In a 40°C (104°F) environment and with the cooling air intake vents blocked, surface temperatures as high as 50°C (122°F) can occur. Before an unsafe temperature is reached, the "High Patient Air Temp" alarm will occur. If this alarm occurs, assure that the ventilator cooling air intake path is free of obstruction and that the patient circuit surface is not heating the patient's skin.



WARNING!

Risk of Electric Shock

Modifying or using the ventilator with accessories that are not compatible may cause cardiac arrhythmia.

The Vivo 45 must only be used in original and unmodified shape and only with compatible accessories.

Inadequate use of device or accessories may cause loss of treatment or decreased performance.



CAUTION!

If you suspect that the device has been mistreated, perform a functional check before taking it to use. A basic functional check can be performed as described in 4.5 *Inspecting the Vivo 45 before Use*, page 35. A complete functional check can be performed by an authorized service technician.



NOTE

Any serious incident that has occurred in relation to this device should be reported to the competent authority and the manufacturer.

2.2 Electrical Safety



WARNING!

Risk of Electric Shock

High voltage contact may cause cardiac arrhythmia.

- Do not operate the Vivo 45 if it has a damaged power cord, power supply or casing.
- To avoid electrical shock, only clean the Vivo 45 according to instructions in this manual. Do not soak or immerse the Vivo 45 into any fluids.
- Use the approved power supply units only.

Use of unapproved power supply units may compromise the electrical isolation and lead to risk of electric shock.

- Do not use more than one multiple portable socket-outlet or extension cord. If a multiple portable socket-outlet is used, it must not be placed on the floor.
- The operator must not touch accessible contacts of connectors and the patient simultaneously.
- Nurse Call must only be connected to a safety extra low voltage system with an isolation from AC power (Mains) voltage which complies with the requirements of IEC 60601-1.

WARNING!

Risk of Faulty Treatment

Electromagnetic Interference may cause electrical equipment to malfunction.

- The aspects of electromagnetic compatibility must be considered.
 - The Vivo 45 should not be used adjacent to or stacked with other equipment; if adjacent or stacked use is necessary, the Vivo 45 should be observed to verify normal operation in that configuration.
 - Mobile or transportable radio transmitters may interfere with the Vivo 45.
 - Further guidance for safe installation of the ventilator can be found in the chapter about emission and immunity declaration.
- If a portable AC power supply is used, make sure that the voltage variations are within the operating limits of the Vivo 45.
- Portable RF communications equipment (including peripherals such as antenna cables and external antennas) should be used no closer than 30 cm (12 inches) to any part of the Vivo 45, including cables specified. Otherwise, degradation of the performance of this equipment could result.



WARNING!

Avoid touching the contacts within the ventilator click-in battery compartment. Under certain circumstances touch current limits per IEC 60601-1 may be exceeded.



2.3 Environmental Conditions

WARNING!

Risk of Intoxication

Do not use the Vivo 45 in a toxic environment.



WARNING!

Risk of Fire

Do not use the Vivo 45 in environments where explosive gases or flammable anesthetic agents present.



WARNING!

The delivered patient air can be as much as 4°C (7°F) higher than ambient temperature. Caution should be exercised if the room temperature is greater than 36°C (97°F).



Risk of Faulty Treatment

If a room humidifier is used, place it at least 2 meters away from the Vivo 45.



Risk of faulty Treatment

The performance of the Vivo 45 may deteriorate at altitudes or ambient temperatures outside the operation conditions specified in the chapter *Technical Specifications*.

- Do not use the ventilator while positioned in a warm place, such as direct sunlight or close to a radiator as this might lead to temperature outside the specifications.
- Do not use the ventilator in an hyperbaric chamber, as this would cause an ambient pressure outside the specifications.
- Do not use the ventilator immediately after storage or transport outside the recommended operating conditions.



Risk of Faulty Treatment



Do not use or store the Vivo 45 in a magnetic resonance (MR) environment. Use of the Vivo 45 in an MR environment may result in malfunction of the Vivo 45 and pose unacceptable risk to the patient, medical staff or other persons.



Unsteady indicated values for delivered volumes or pressures and the occurrence of alarm conditions without apparent cause may be an indication of loss of performance due to electromagnetic disturbances. Follow the instructions above and the guidance provided in 8.3 *Emission and Immunity Declaration*, page 133 to mitigate the effects of electromagnetic disturbances.

CAUTION!



The ventilator, any accessories and all replaced parts, must be disposed of in accordance with the local environmental regulations regarding the disposal of used equipment and waste.

2.4 Usage of Patient Circuit

WARNING!

Risk of Insufficient Ventilation

Insufficient ventilation may cause transient hypoxia.



The Vivo 45 ventilator is intended to be used with patient circuits with intentional leakage and compliant to ISO 17510. Recommended leak rate: 20 to 50 liters per minute at 10 cmH₂O.

Failure to use a mask or accessory that minimizes rebreathing of carbon dioxide or permits spontaneous breathing can cause asphyxiation.

Risk of Insufficient Ventilation

Insufficient ventilation may cause transient hypoxia.

Before use:



- Make sure that the patient circuit and joined parts are undamaged and correctly connected, in order to avoid unwanted leakage.
- The leakage port of the patient circuit or patient interface prevents rebreathing by flushing the exhaled air. It should be located as near the patient interface as possible (this is even more important for treatments with low pressure). Make sure that it is not blocked or obstructed.
- The Vivo 45 should be turned on and the function of the leakage port should be checked before use:

Risk of Suffocation



If the patient needs assistance to remove the patient interface, the patient shall not be left alone. This is to avoid the risk of re-breathing of CO₂ in case of accidental ventilator failure.

Do not breathe through the connected patient circuit unless the ventilator is turned on and operating properly.

WARNING!



Risk of Electric Shock

Do not use antistatic or electrically conductive hoses or tubing with the ventilator breathing system. This could result in electrical shock.

WARNING!



Patient connected parts and all filters must be replaced regularly to ensure correct function of the ventilator. All replaced parts must be disposed of according to local environmental regulations regarding the disposal of used equipment and parts.



By conducting a pre-use test (see 4.7 *Performing the Pre-use Test*, page 36) the compatibility of the complete patient circuit configuration with the ventilator can be verified. If a pre-use test is successfully performed the circuit configuration meets the required characteristics.

Always perform a pre-use test when the patient circuit is replaced or modified. Also check the alarm settings as changes to the patient circuit may affect the alarm triggering.

Risk of Suffocation

Periodically check for moisture in the patient circuit.

When present, remove the moisture. Before attempting to dry the circuit, disconnect it from the Vivo 45 to ensure no water flows back into the Vivo 45.



The frequency at which these checks must be performed will depend on the patient's condition and the device used. The responsible caregiver should assess this on an individual basis in accordance with the patient's needs.

Risk of Insufficient Ventilation

Insufficient ventilation may cause transient hypoxia.

The use of equipment such as endotracheal tubes, oral/nasal tubes, adaptors etc. with small inner diameters or high resistance filters, humidifiers etc. increase the resistance in the patient circuit which may interfere with the operation of the patient disconnect function. It may also interfere with the device trigger function.



This impact can be reduced by conducting a pre-use test.

Risk of Constriction

Entanglement with cables or tubing constricting airways may cause asphyxiation.



Do not leave long lengths of air tubing or cables around the top of the bed. They could twist around the patient's head or neck while sleeping.



The ventilator is equipped with a rebreathing alarm. The alarm is not a substitute for operator vigilance in ensuring that the leakage port remains clear at all times. Periodically check the patient circuit during therapy.



In general, as pressure decreases, the potential of rebreathing increases. Lower pressures produce less flow through the leakage port which may not clear all CO₂ from the circuit to prevent rebreathing.

WARNING!



Risk of Cross-Contamination

Patient circuits might get contaminated by exhaled gases. To avoid cross-contamination, always use a properly cleaned or a new patient circuit when the Vivo 45 is to be used by a new patient.



NOTE

For masks and accessories, always follow the manufacturer's instructions.

2.5 Usage of Filters



WARNING!

Always use the ventilator with patient air inlet filters installed. Only use the ventilator with accessories recommended by Breas Medical.

Risk of Overheating

Replace or clean the air inlet filters as specified in the *Maintenance* chapter.

Using old or clogged filters may cause the Vivo 45 to operate at higher temperatures than intended.

When operating the Vivo 45, make sure that the air inlet and filters are not obstructed or occluded.

Risk of Insufficient Ventilation

Insufficient ventilation may cause transient hypoxia.

Do not use high resistance bacteria filter at the air outlet of the Vivo 45. High resistance bacteria filters placed between the air outlet and the patient interface may interfere with the operation of the patient disconnect function. It may also interfere with the device trigger function.

When adding, changing or removing any kind of filter, always reassess the settings, including alarm settings and perform a pre-use test.



WARNING!

Risk of Cross-Contamination

Deep tissue or mucosal contact with infectious agents may cause infections.

If the Vivo 45 is used by several patients, a low resistance bacteria filter shall be used between the air outlet and the patient circuit, for preventing patient cross-contamination. Reuse of bacteria filter, patient circuit or mask may expose patients to contagious agents.



2.6 Humidification



WARNING!

When adding or removing an HME (Heat and Moisture Exchanger, artificial nose) or HCH (Hygroscopic Condenser Humidifier), always reassess the settings, including alarm settings, and perform a pre-use test.

Risk of Suffocation

When the attachable humidifier is installed, the Vivo 45 must be located below the patient and on a flat surface. This is to prevent personal injury from accidental spillage or from excess water or condensation flowing down the patient tube and into the patient's mask. Extra cautions should be taken for patients who are unable to guard their airways or cannot pull off the mask.

When using a humidifier or a nebuliser any patient air filter will need more frequent replacement to prevent increased resistance or blockage.

The ventilator accuracy can be adversely affected by the gas added by the use of a pneumatic nebuliser.



WARNING!

Risk of electric shock

If using the protective cover or the carry bag, first remove the attachable water chamber. Water spillage may cause electric shocks.





WARNING!

The use of a heated wire patient circuit decreases condensation in the patient circuit.



In case of invasive application, the use of an appropriate external heated humidifier or HME is recommended.



If the condensation in the patient circuit is excessive, the use of a heated humidifier may require the installation of a water trap in the circuit. The water trap prevents any condensed water in the patient circuit from running into the patient airways and causing personal injury.



Any external humidifier connected to the ventilator must comply with ISO 8185 or 80601-2-74.



Any HME connected to the ventilator must comply with ISO 9360.



Do not add any attachments or accessories to the humidifier that are not listed in the instruction for use of the humidifier or the humidifier might not function correctly affecting the quality of the therapy or injuring the patient.



The use of an HME or an external humidifier may require readjustment of the ventilator low-pressure alarm.



Certain HMEs and HCHs are sufficient to provide humidification when the ventilator is used invasively. Check specific suppliers' recommended use.

2.7

Cleaning and Maintenance



WARNING!

Risk of Electric Shock

Cleaning with excessive water or opening the device's casing without certified training may cause electric shocks.

The Vivo 45 should be regularly cleaned and maintained in accordance with this operating manual.



WARNING!

Risk of Faulty Treatment

Service and Maintenance of the Vivo 45 shall not be performed when the Vivo 45 is in use.



WARNING!

Risk of Electric Shock

High voltage contact may cause cardiac arrhythmia.

Repairs and modifications must be carried out by authorized technicians only and in accordance with instructions from Breas Medical

- The Vivo 45 must not be opened, repaired or modified by unauthorized personnel or interconnected with incompatible equipment. If subjected to unauthorized modifications or operations, Breas Medical is no longer responsible for the device's performance and safety and all warranties will become invalid.



CAUTION!

Do not attempt to autoclave or sterilize the Vivo 45.

2.8 Usage of Oxygen

When using the Vivo 45 with oxygen, always follow the oxygen provider's instructions and use only medical grade oxygen complying with local regulations.

WARNING!



As this medical device uses an alternative small-bore connector design different from those specified in the ISO80369 series, there is a possibility that a misconnection can occur between this medical device and a medical device using a different alternative small-bore connector, which can result in a hazardous situation causing harm to the patient. Special measures need to be taken by the user to mitigate these reasonable foreseeable risks.

WARNING!



Risk of fire

The presence of oxygen can speed up combustion of inflammable materials.



Risk of Fire

When oxygen is used with the Vivo 45, the oxygen flow must be turned off when the Vivo 45 is not operating. Oxygen delivered into the patient tubing may accumulate within the machine enclosure. Oxygen accumulated in the machine enclosure increases the risk of fire.

WARNING!



Do not use a humidifier between the oxygen source and the ventilator, in order to humidify the oxygen flow.

If humidification is required, use the attachable humidifier or an external humidifier after the patient air outlet.

WARNING!



Risk of Fire

Ventilate the room adequately. Do not smoke in a room where oxygen is being used.



Risk of Fire

Naked light bulbs and other sources of ignition must be kept a minimum of 2 meters (6 feet) away from the oxygen cylinder, the patient circuit or any other oxygen carrying parts.



Risk of Fire

Do not use aerosols or solvents close to the oxygen supply, even when the oxygen supply is shut off.

WARNING!



Supplemental oxygen with a flow up to 30 l/min can be added by an oxygen source with rotameter such as oxygen cylinder, central oxygen supply system or an oxygen concentrator.

Risk of faulty Treatment

At a fixed flow rate of supplemental oxygen flow, the inhaled oxygen concentration will vary, depending on the pressure delivered, the patient's breathing pattern, the patient interface and the leak rate.

To monitor the oxygen concentration, use the FiO₂ sensor accessory.



Supplemental oxygen flow and pressure must not exceed 30 l/min and 100 kPa.



CAUTION!

Supplemental oxygen is added before the volume measurement sensor and thereby included in the measurements. However, the oxygen concentration still has influence on the volume measurement of the delivered air.

This measurement is based on a normal oxygen concentration of 21%. If the oxygen concentration is higher, the actual inspired volume will deviate from the monitored volume as follows:

- 40% oxygen concentration: -2.5% deviation
- 60% oxygen concentration: -5% deviation
- 80% oxygen concentration: -7.5% deviation

3 Product Description

3.1 Main Components



This section describes the components of the Vivo 45 medical electric equipment.

NOTE

- There might be local variations of the main components configuration.
- The standard Vivo 45 and its packaging do not contain any natural rubber latex.

Carry bag

Function: Storage for transportation

Part No: 006014



Manual

Function: Product and usage information

Part No:

User's manual:

006149

Clinician's manual:

006148

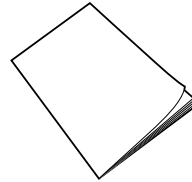

Patient Circuit

Function: Delivers air to the patient (applied part)

Delivered patient circuit depends on the sales configuration. See 9 *Accessories and Parts*, page 139 for compatible patient circuits.

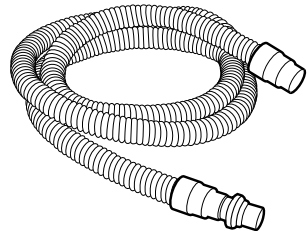

Patient air inlet filter, fine, white, disposable

Function: Fine inlet air filtration.

Material: AS 100

NaCl Penetration: (0.65 μm NaCl @ 95 l/min) = <7.35%

Part No: 007103 (5pcs)



Power Supply

Function: Deliver power to the ventilator

Part No: 006396

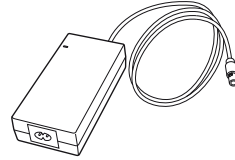

Power cord

Function: Deliver power to the AC power supply

Part No:

GB: 003521

CN: 005304

EU: 003520

JP: 004834

US: 003522



Vivo 45 Main Unit

Main Unit

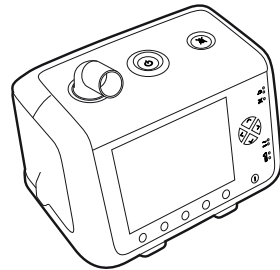

3.2 Front View

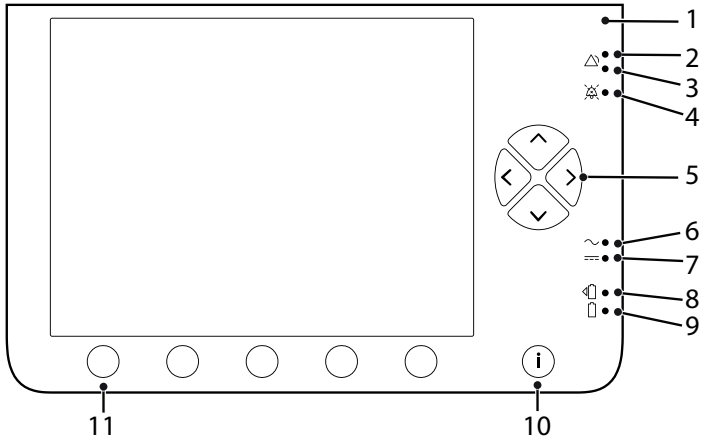

No	Item	Function
1	Sensor	Ambient light sensor
2, 3	Alarm (red & yellow) LEDs	Alarm indication: Red = High priority Yellow = Medium priority
4	Audio pause LED	Paused alarm sound indication
5	Navigation /Setting buttons	Navigate on the display /Define settings
6	Mains LED	Power source indication: Mains
7	External DC LED	Power source indication: External DC
8	Click-in battery LED	Power source indication: Click-in battery
9	Internal battery LED	Power source indication: Internal battery
10	Information button	Show / Hide information texts
11	Navigation /Function buttons	Functions according to the display

3.3 Side Views

Click-in compartment side

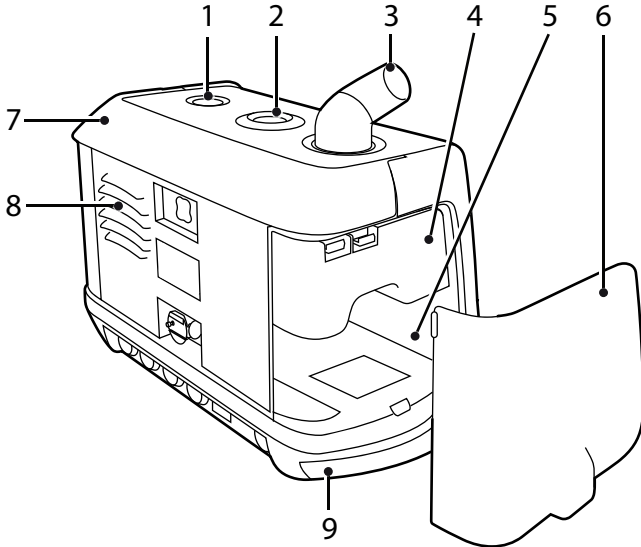

No	Item	Function
1	Audio pause	Pause the alarm sound
2	Start/Stop	Start/Stop ventilation treatment
3	Patient air outlet	Connection for patient circuit
4	Air bypass unit	Click-in airway/silencer for use without the click-in humidifier. (If the click-in humidifier is used, it replaces the air bypass unit)
5	Click-in compartment	Compartment for either of the accessories click-in humidifier or click-in battery.
6	Side panel	Cover
7	Carrying handle	Handle for lifting the ventilator
8	Cooling air outlet	Outlet internal cooling
9	Cooling air inlet	Inlet internal cooling

Filter Side

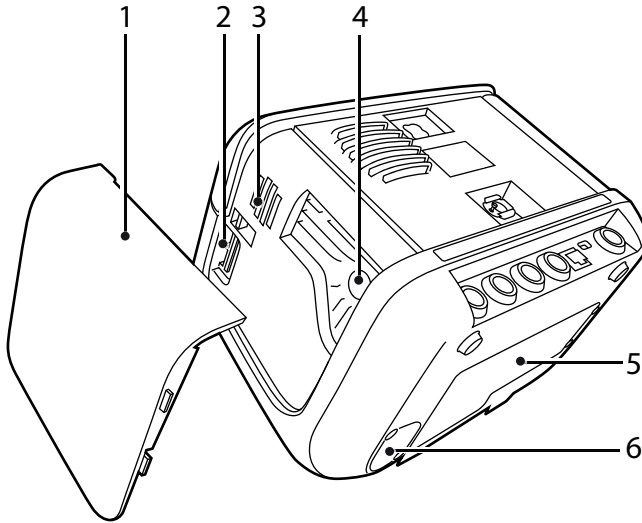

No	Item	Function
1	Side panel	Cover
2	Memory card slot (SD card)	Memory download
3	Alarm beeper	Alarm Sounds Output
4	Patient air inlet	Air bypass unit in, replaceable filters
5	Internal battery	Compartment for the internal battery
6	FiO ₂ sensor hatch	Compartment for the optional FiO ₂ sensor

3.3.1 Detaching and Reattaching the Side Panels

Detaching the Filter Side Panel

- 1 Lift the handle to access the release button (A).
- 2 Looking from behind, to dismount the filter side panel press the button above the panel (B). The panel is released.
- 3 Remove the panel. (C)

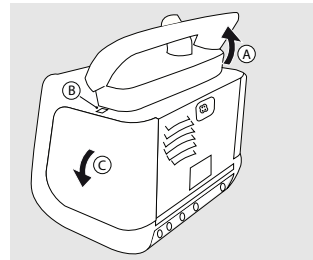

Reattaching the Filter Side Panel

- 1 Lift the handle to access the release button (A).
- 2 To mount the filter side panel, insert the tabs (B) on the lower side of the panel into the holes (C).
- 3 Press the side panel into the casing until it clicks in place at the button (D).

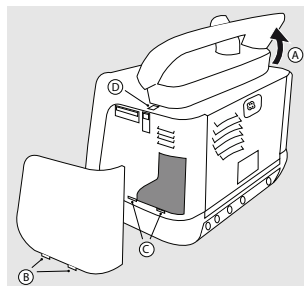

Detaching the Click-in Compartment Side Panel

- 1 Lift the handle to access the release button (A).
 - 2 Press the button marked "1". (B).
- ⇒The panel is released.
- 3 Remove the panel (C).

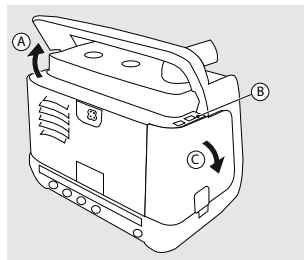





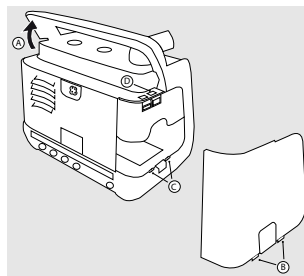



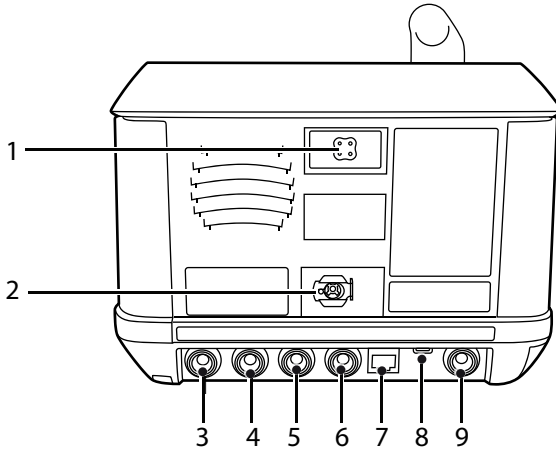

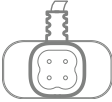



Reattaching the Click-in Compartment Side Panel

- 1 Lift the handle to access the release button (A).
- 2 To mount the click-in compartment side panel, insert the tabs (B) on the lower side of the panel into the holes (C).
- 3 Press the side panel into the casing until it clicks in place at the button (D).





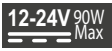









3.4 Equipment Designation









No	Item/Symbol	Description	Colour
1		Electrical connector, for power to the heated patient circuit.	
2		Connection for low pressure/bleed-in oxygen source	
3		CO ₂ interface port	
4		SpO ₂ interface port	
5		Remote start/stop, Audio pause, and effort belt interface port	
6		Remote alarm and Nurse call interface port	
7		Network connection port	
8		USB data connection port	
9		Mains/External DC inlet	

3.4.1 Additional Symbols

This section describes symbols and markings that might appear on the parts or packaging of the Vivo 45.

Symbol	Description
	Internal battery
	Product number
	Read user instructions.
	Attention: Read the intended use in the manual. Read the Safety chapter in the manual.
	This product must not be exposed to open fire.
	This product should be recycled.
	Read 7.7 <i>Disposal</i> , page 123 for information about recycling and disposal.
IP22	Degree of protection provided by enclosure: IP22. See 8.2.6 <i>Environmental Conditions</i> , page 131 for detailed information.
	Manufacturer
	Serial number
	This product is a Medical Device.
	Date of Manufacture
	IEC protection Class II: Double insulated equipment.
	Indication of applied parts (IEC 60601-1 Type BF, Isolated Applied Part)
Rx Only	(Symbol only applicable in U.S.) Caution: U.S. Federal law restricts this device to sale by or on the order of a licensed healthcare practitioner.

Symbol	Description
	<p>Meets all requirements for CE marking according to relevant European health, safety and environmental protection legislation</p>
	<p>Meets all requirements for UKCA marking according to applicable United Kingdom health, safety and environmental protection legislation.</p>
	<p>Do not obstruct air inlets or outlet.</p>
	<p>Single patient multiple use.</p>
	<p>Single patient multiple use.</p>
	<p>Hot Surface. Do not touch. (Heating plate in click-in compartment.)</p>
	<p>MR Unsafe. The device should not enter a magnetic resonance (MR) environment, such as an MRI scanner room.</p>

4 Preparing the Vivo 45 for Use



WARNING!

Read 2 *Safety Information*, page 12 before setting up the Vivo 45.

4.1 Checking the Vivo 45 before First Use

When using the Vivo 45 for the first time, follow the instructions below:

1 Check that all main components and ordered accessories have been delivered (refer to the packing note or the invoice, if available).



2 Ensure that the equipment is in good condition.

3 If stored more than 1 month, connect the Vivo 45 to the power supply to recharge the internal battery.

4 Check that the grey and white air filters are installed.

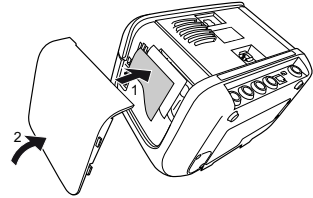

4.2 Placing the Vivo 45



WARNING!

Read 2.3 *Environmental Conditions*, page 15 carefully to make sure all conditions are met and considered.

1 Place the Vivo 45 on a solid, flat, and clean surface. The Vivo 45 should be placed lower than the patient in order to prevent the device from falling on the patient, as well as preventing condensed water from reaching the patient.

Overnight, the Vivo 45 should be placed close enough to the patient's bedside to allow movements during the sleep without pulling the Vivo 45 off its surface.

2 Make sure that nothing can block the patient air inlet.

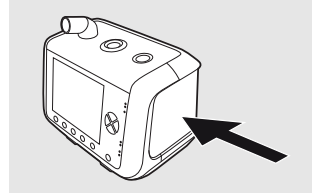
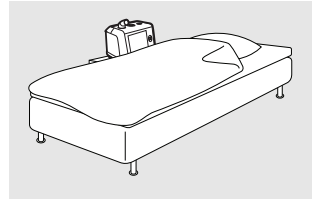

3 Make sure that nothing can block the cooling air inlet or outlet.

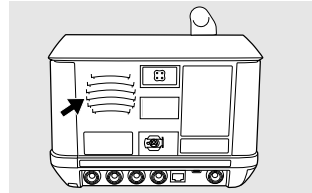
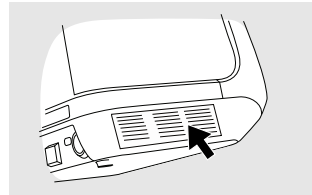

4 Make sure that the controls are accessible for the operator.

CAUTION!

- Do not place the Vivo 45 on a soft surface that will prevent the air flow underneath the device.
Never cover the device.

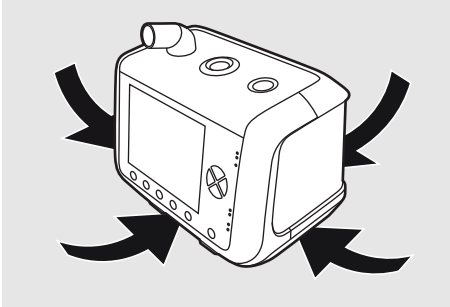

- Always position the Vivo 45 so the power supply lays on a surface without strain to the power cord. The power supply shall be easy to disconnect, if required to isolate the Vivo 45 from the mains.



4.3 Connecting the Vivo 45 to Mains



WARNING!

Read 2.2 *Electrical Safety*, page 14 carefully to make sure all conditions are considered and met.

1 Plug the power supply into the power inlet of the Vivo 45.

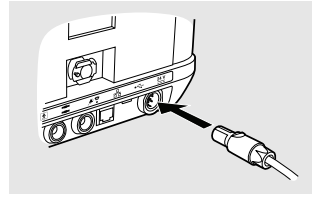

2 Make sure a clicking sound is heard to ensure the power supply is completely inserted.

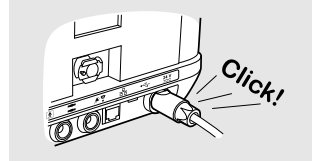

3 Connect the power supply's power cord to the mains supply.

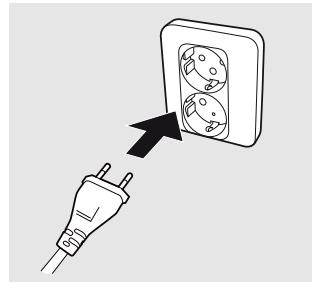

To isolate the Vivo 45 from the mains supply, disconnect the power supply.

4.4 Connecting the Patient Circuit



WARNING!

Read 2.4 *Usage of Patient Circuit*, page 16 carefully to make sure all conditions are considered and met.

Connect the Patient Circuit

- 1 Inspect the circuit for damages.
- 2 Connect the patient circuit to the patient air outlet on the ventilator.

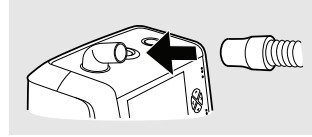

- 3 If having a heated patient circuit, connect the heated wire electrical plug to the socket on the ventilator.

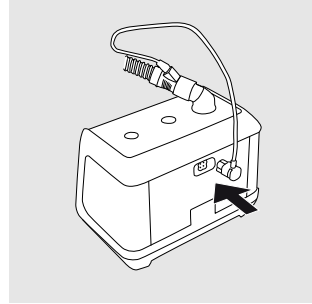

- 4 Connect the other end of the circuit to a leakage port or to a patient interface with integrated leakage port.

4.5 Inspecting the Vivo 45 before Use

Inspection of Device

- Check that there is no visible damage.
- Check that the surface is clean.

Inspection of Cables

- Check that all cables are recommended by Brea.
- Check that the cables are undamaged.
- Check that the cables are properly connected.

Inspection of Placement

- The Vivo 45 shall be placed on solid flat surface below the patient level (see 4.2 *Placing the Vivo 45*, page 31).
- Make sure that nothing can block the air inlet at the side.

Inspection at Ventilator Startup

This procedure checks the ventilator's alarm handling and power source handling. If any check fails, take the ventilator out of use and contact your service provider.

- 1 Connect a patient circuit to the ventilator
- 2 Connect the power supply to the ventilator. If the power is supply is connected and the ventilator is turned off, press the Start/Stop button.

⇒The ventilator now turns on and enters stand by mode. If it is the first time the ventilator is turned on, you also have to select language.

- 3 If needed, perform a pre-use test.
- 4 Press and hold the Start/Stop button until the progress bar is filled to start the treatment.

⇒At the start of the treatment the ventilator performs an alarm test. Check that:

- The alarm LEDs flash
- The ventilator beeps

- 5 Disconnect the power supply for more than 5 seconds.

⇒The ventilator now switches to the internal battery (or click-in battery, if connected). Check that *Lost mains power* alarm is given.

- 6 Reconnect the power supply.

Check that the device switches to the mains supply, indicated by an information message and a beep.

- 7 Ensure that the treatment settings and alarm settings are set as prescribed before taking the ventilator to use.

4.6 Adjusting the Vivo 45 Patient Settings



WARNING!

The configuration of the Vivo 45 therapy settings must always be prescribed by a licensed physician and carried out by an authorised health care professional.

For detailed information about the treatment parameters of the Vivo 45, see 5.5 *Functions and Parameters in the Vivo 45*, page 56.

Follow the instructions below when setting up the Vivo 45:

- Adjust the settings to find the best possible breathing comfort for the patient.
- If you have changed the ventilation mode, press **Select Next** and review the settings before pressing **Confirm**.
- Always document the patient settings.
- The ventilator always starts in the mode and with the settings that were active when it was switched off.

4.7 Performing the Pre-use Test

The pre-use test is used for detecting the characteristics of the patient circuit that is connected to the Vivo 45.

The patient shall not be connected during the pre-use test.



CAUTION!

Always perform a new pre-use test if the patient circuit configuration has been changed.



NOTE

If the pre-use test has not been performed, the Vivo 45 will operate with default patient circuit compensation.

Starting the Pre-use Test Manually

- 1 On the **Others** menu, Select **Pre-use Test** and then **Start Pre-use Test**.
- 2 Follow the instructions on the display.

Activating the Pre-use Test Prompt

- 1 On the **Others** menu, Select **Pre-use Test**.
- 2 Set **Pre-use Test** to **On**.

Pre-use Test Sequence

When performing a pre-use test, the instructions on the display will guide you through this sequence:

Step	Action
1	Start of pre-use test.
2	Connect the patient circuit.
3	Make sure that nothing is blocking the patient end of the circuit.
4	Wait while the Vivo 45 is checking the patient circuit resistance. If the resistance is not within the limits, the test will end without performing the following steps. The result will be displayed for review.
5	Block the end of the patient circuit with an air tight object.
6	Wait while the Vivo 45 is checking the patient circuit compliance and leakage.
7	Test finished. Review the test result.

4.7.1 Actions At Pre-Use Test Failure

At the end of the pre-use test the individual results for leakage, resistance and compliance are shown.

Failure Due To Incorrect Leakage

Indication: **Leakage: Fail**

- 1 Check the ventilator set-up (circuit, filters, humidifier, etc.) for leakage.
- 2 Ensure that all connectors are tightly fitting.
- 3 Run the pre-use test again.
- 4 Replace the circuit if the test is failed repeatedly.

Failure Due To Incorrect Resistance or Compliance

Indication: **Resistance: Fail** or **Compliance: Fail**

- 1 Check the ventilator set-up (circuit, filters, humidifier, etc.) for blockage or pinched tubing.
- 2 Run the pre-use test again.

If the pre-use test is continually failed due to resistance or compliance, it is permitted to use the ventilator but be aware that the pressure (resistance) or volume (compliance) delivered to the patient may not meet with the specified accuracy.

The ventilator will apply the default values to compensate for circuit resistance and compliance. These values will deviate from the values for the circuit in use.

Ensure that the delivered ventilation is closely monitored.

5 How to Use the Vivo 45



WARNING!

Read 2 *Safety Information*, page 12 before using the ventilator.

When the ventilator is handed over to the patient, the physician in charge or hospital staff must instruct the patient in how the unit works.

5.1 Switch the Vivo 45 On and Off

Switch On and Enter Standby Mode

1 If having access to mains power, connect the mains power supply.

⇒The Vivo 45 now starts up and enters standby mode.

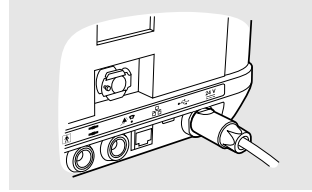

2 If running the Vivo 45 on the internal battery or the click-in battery, press the Start/Stop button.

⇒The Vivo 45 now starts up and enters standby mode.

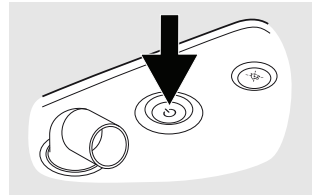

3 Select Yes/No when asked to “Perform Pre-use Test”. (The Vivo 45 may be configured to not ask for pre-use test at start up. See 5.2.9 *The Others Section* , page 49.

Start the Treatment

1 Press and hold the Start/Stop button on the Vivo 45.

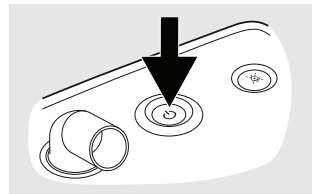

2 Release the Start/Stop button when the progress bar is filled.

Tip: You can also press the start button shortly and then press the “Yes” button when asked to start the treatment.

Start the Pressure Ramp

If the treatment has been configured to allow pressure ramp, it can be started or stopped by the Ramp button. The Ramp buttons are only available after the treatment is started

- 1 Open the second Setup page by pressing the Setup button twice.

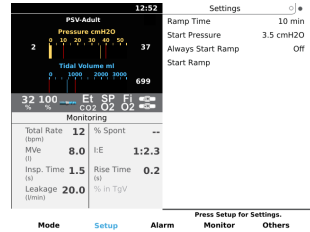

- 2 Select Start Ramp using the Up and Down arrow buttons and then Start the ramp by pressing the Right Arrow button.
- 3 Confirm to start the ramp.

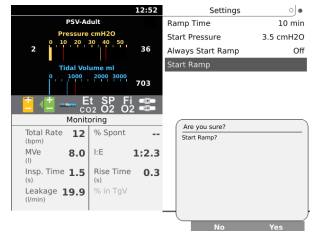

- 4 Read and acknowledge the information message regarding reduced alarm functionality during the ramp period.

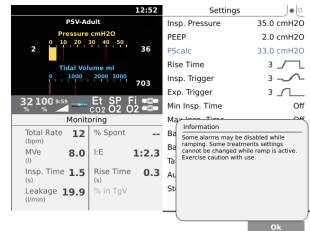

Stop the Pressure Ramp

- 1 Open the second Setup page by pressing the Setup button twice.

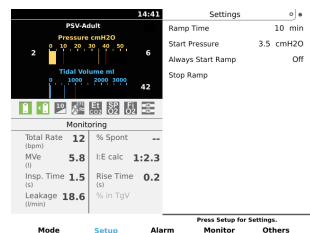

- 2 Select **Stop Ramp** using the Up and Down arrow buttons and then stop the ramp by pressing the Right Arrow button.
- 3 Confirm to stop the ramp.

Stop Treatment and Switching Off

1 To stop treatment and enter standby mode, first press and hold the Start/Stop button on the front panel.

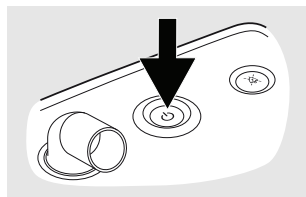

2 Release the Start/Stop button when the progress bar is filled.

3 Press “Ok” or the Audio Pause button to stop the treatment. To cancel the stopping process and continue the treatment, press “Cancel”.

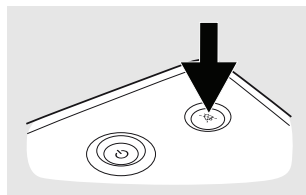

5.2 Using the Menu

5.2.1 Navigating with the Buttons

Use the five navigation buttons and the up and down buttons on the panel in order to navigate the menu.

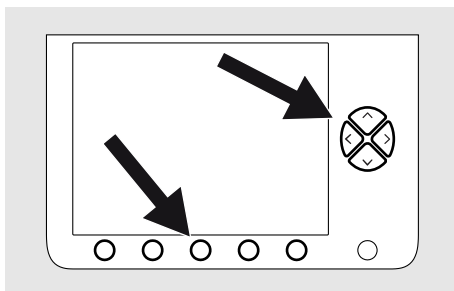

The navigation buttons are used to view the different sections defined above each navigation button. The same navigation button can also be used to view additional information in some sections, or it can be designated a temporary function while an event window is active.

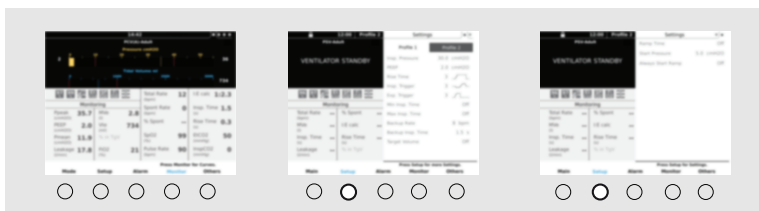

- The currently displayed section is indicated by a title in blue text.
- For sections with multiple pages, press the navigation button repeatedly to circle between the pages. Multiple pages are indicated by dotted tabs in the upper right corner.



NOTE

Use the up or down button to enter the menu list.

Use the up and down buttons to navigate up or down in a menu list, or to select different parameters. Use the left and right buttons to alter parameters, or enter and exit sub sections.

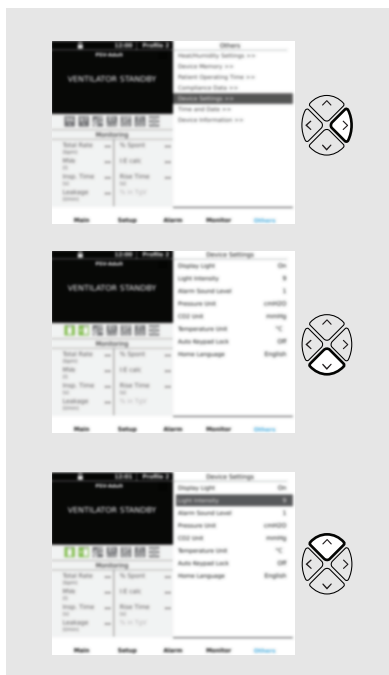

5.2.2 Symbols Used in the Menu



Internal battery.

For detailed information about charge level indications, see 5.6.4 *Battery Icons* , page 65.



Click-in battery level

For detailed information about charge level indications, see 5.6.4 *Battery Icons* , page 65.



Home Mode activated



Ramp function active

The ramp time in minutes is indicated by a number above the ramp symbol.



Connected to nurse call system



Remote alarm unit connected



Humidifier and/or heated circuit connected

The number in the drop symbol indicates the humidity setting. If the humidifier is connected but not activated, the drop is crossed over. The temperature above the heating waves symbol indicates the temperature setting for the heated circuit. If the heated circuit is connected but not activated, the temperature is replaced by “Off”.



Single limb circuit with leakage port selected (Leakage)



MPV breath mode selected.

Circuit with mouthpiece interface shall be used.



SpO₂ sensor connected



FiO₂ connected



EtCO₂ connected



PtcCO₂ connected



Effort belt connected

Connection failures are indicated by red coloured belts.



Multiple pages



High priority alarm event in history list



Medium priority alarm event in history list

Size and colour of symbols may vary depending on displayed view.

5.2.3 Menu Overview

In *Home Mode*, the Vivo 45 menu has the following section layout:

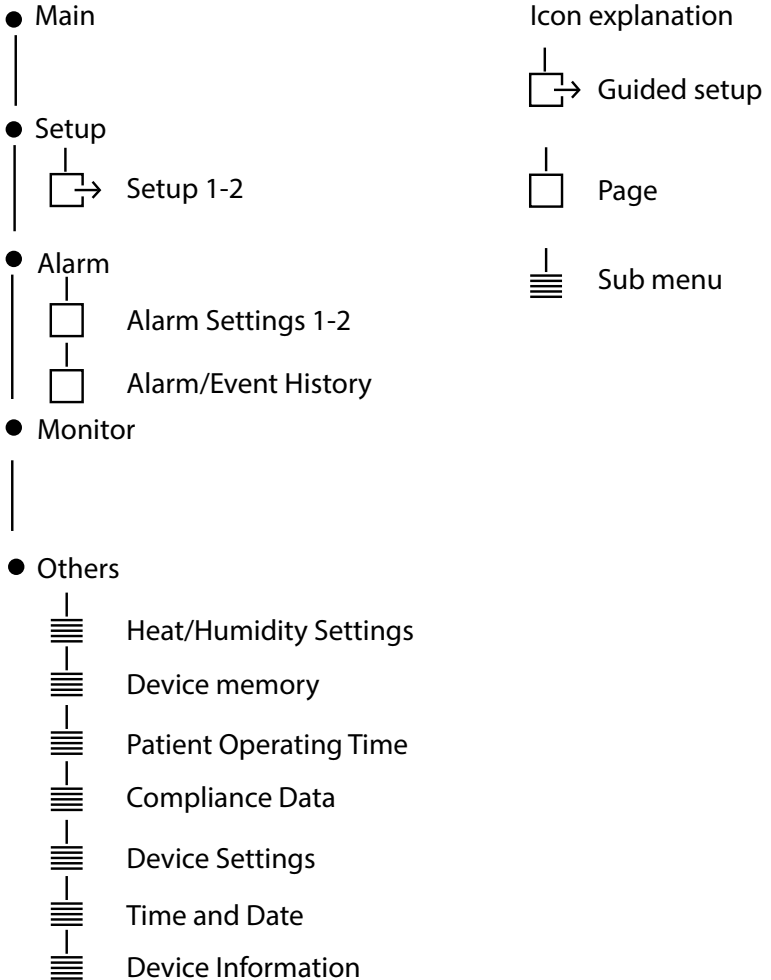

5.2.4 Display Overview

This section describes the areas on the display.

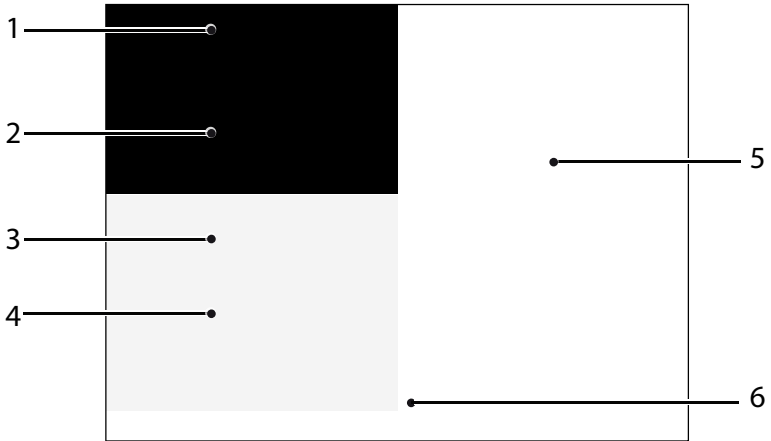

1. Title and Icons

Ventilation mode, breath mode, patient mode and device mode are displayed. When more than 1 profile is used, the active profile is displayed.

2. Pressure and Volume Indicators

The bar graphs are used to display current pressure, PEEP, Ppeak, pressure and volume alarm limits, and expired tidal volume.

The red lines represent the low and high pressure alarms, the low and high tidal volume alarms.

3. Icons/Alarm Message

Information icons are presented here to give a quick overview of the Vivo 45 basic status (see 5.2.2 *Symbols Used in the Menu*, page 42).

4. Monitoring Field

This field is designed to give a brief overview of the key monitor values. Navigate to the Monitor section for the all available values.

5. Screen Title and Context Area

This field displays settings and information for the section. Screen title, page number (if more than one sub page exists in the section) and time are also displayed.

6. Navigation Field

This field is mainly used for displaying the section layout of the menu, and determines the function of each navigation button. Depending on current operation, the navigation buttons can be assigned temporary functions such as “Yes” or “Next”, depending on which operation is active.

5.2.5 The Main Display, Home Mode

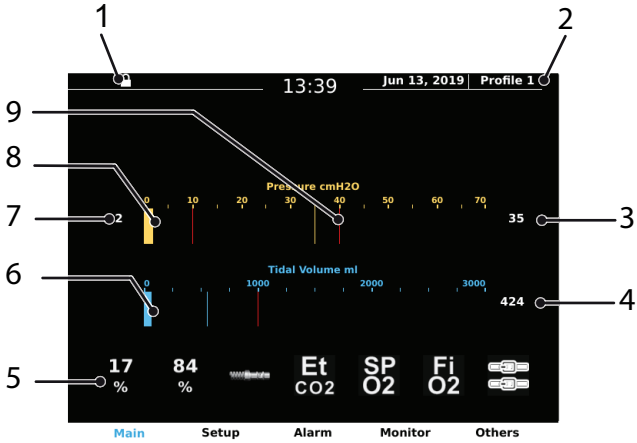

1. Indication of home mode lock status. See 5.2.2 *Symbols Used in the Menu*, page 42 for information about each icon.
2. When more than 1 profile is used, the active profile is displayed.
3. Ppeak (max pressure during last breath)
4. Tidal volume during last breath
5. Indication of battery status and connected sensors. See 5.2.2 *Symbols Used in the Menu*, page 42 for information about each icon.
6. Bar graph representing the tidal volume
7. PEEP value
8. Bar graph representing the current pressure
9. Red lines in the bar graphs represent alarm limits

5.2.6 The Setup Section, Home Mode

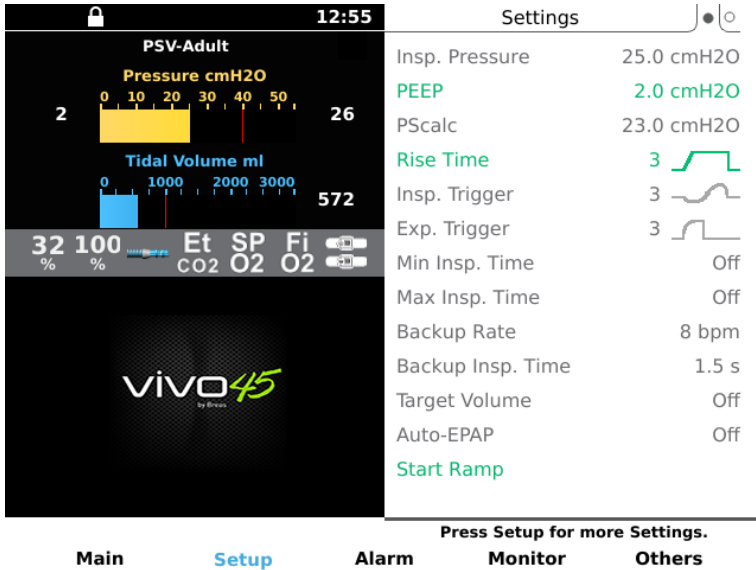

In the Setup section, treatment parameters can be viewed. See 5.5 *Functions and Parameters in the Vivo 45*, page 56.

If Home Adjust is activated, some parameters might be adjustable within ranges defined by the prescribing physician. Adjustable parameters are indicated by green text.

If profiles with preset treatment settings have been created, the profiles are selected from the Setup section. The currently active profile is indicated by a frame.

Selecting a Profile

This procedure describes how to select between preset treatment profiles in home mode, if more than one profile has been created by the clinician.

- 1 Press the **Setup** button to display the Setup section.
- 2 Press the Down or Up arrow button to enter the Profile selection.
- 3 Press the Right or Left arrow to select a profile.

The treatment settings for the profile are displayed below the profile selection.

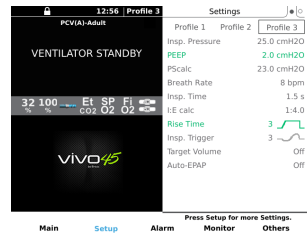

- 4 Confirm the change of Profile by pressing the **Yes** button.

5.2.7 The Alarm Section

12:55 Alarm Settings

PSV-Adult

Pressure cmH2O

26

Tidal Volume ml

581

32 100 Et SP Fi

% % CO2 O2 O2

vivo45 by Breco

High Pressure	40.0 cmH2O
Low Pressure	10.0 cmH2O
High Vte	1000 ml
Low Vte	Off
High Breath Rate	Off
Low Breath Rate	Off
High MVe	Off
Low MVe	Off
Apnea	Off
Disconnection	On
Obstruction	Off
Rebreathing	On

Press Alarm for more Alarm Settings.

Main Setup Alarm Monitor Others

The Alarms section contains 3 pages: The two first are for viewing alarm settings and the third is for viewing the alarm and message history. Shift between the pages by pressing the Alarm button.

5.2.8 The Monitor Section

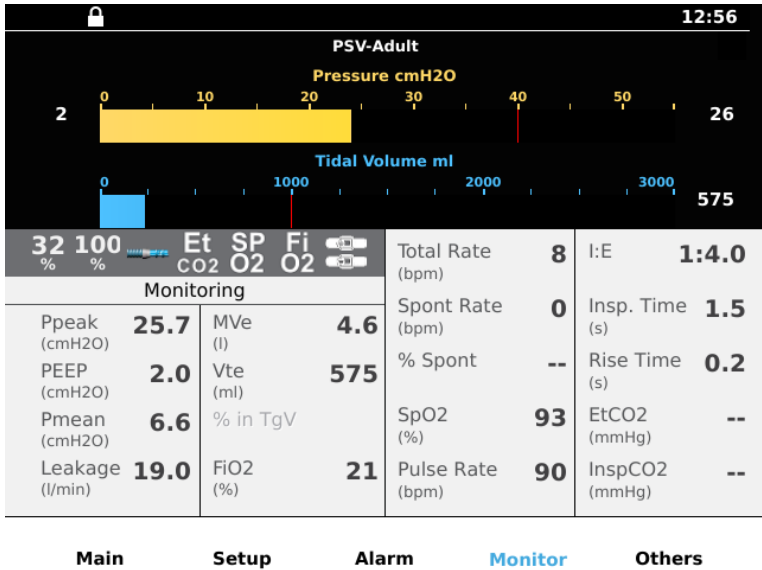

The monitoring page contains bar graphs for pressure and volume, and a field with measurement readings for the monitored values that are applicable for the treatment mode. See 5.3 *Monitored Values in the Vivo 45*, page 50 for a description on the monitored values.

5.2.9 The Others Section

5.2.9.1 Heat/Humidity Settings

- Humidifier Setting - Sets the level of humidity.
- Humidifier - Activates or deactivates the humidifier.
- Heated Circuit Temp - Sets the temperature of the heated circuit.
- Circuit Heating - Activates or deactivates the circuit heating.

5.2.9.2 Device Memory

The Device memory setting is used for transferring data to a memory card and for erasing the device data (requires Clinical mode).

5.2.9.3 Patient Operating Time

Shows the number of hours a patient has been using the Vivo 45 for breathing therapy.

5.2.9.4 Device Settings

General settings for the Vivo 45:

- Display Light: On (will keep the display lit up regardless of use), Auto (will adjust the light intensity depending on the ambient light), Delayed (the display is dimmed after 30 seconds or more depending on the mode and battery setup. If any button is pressed or any alarm occurs, the display light will return to normal again).
- Light Intensity (setting range: 1-9, where 1 is the lowest and 9 is the highest light intensity setting. In cases where Display Light is set to “Auto”, the Light Intensity setting will not be available).

If the light intensity is set too low, ambient light could cause difficulties in reading the alarm text.

- Auto Keypad Lock (On, Off).
- Home Language: Selects the language for Home Mode.

5.2.9.5 Time and Date

- Time (set time: hours and minutes).
- Time Format (choose between 24 h or 12 h am/pm format).
- Date Format (choose between yyyy-mm-dd, dd/mm/yyyy, mm/dd/yyyy format).
- Date (set date: year, month and day).

5.2.9.6 Device Information

- Device Operating Time (hours)
- Firmware Version
- Language: Clinical Mode
- Language: Home Mode
- ~ AC (On/Off)
- External DC (V)
- Battery Health (%)
- Serial Number

5.3 Monitored Values in the Vivo 45

Values monitored by the Vivo 45 stored in the data log and displayed on the screen:

1. The monitoring screen:

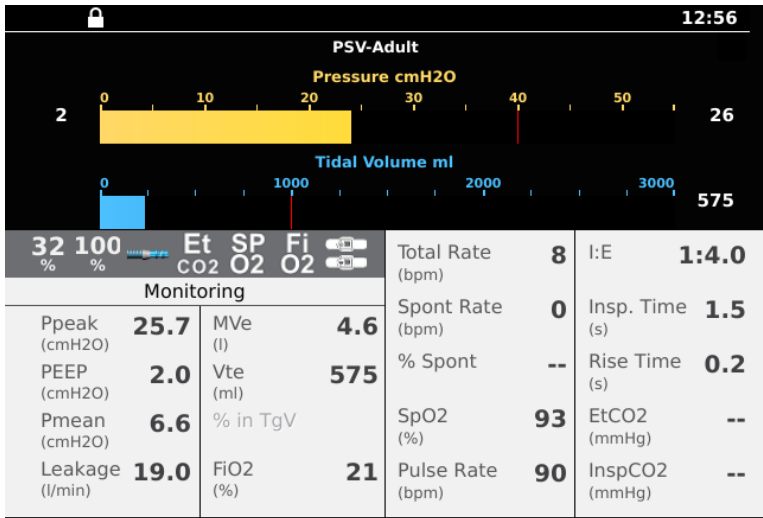

Main Setup Alarm Monitor Others

2. The monitoring field:

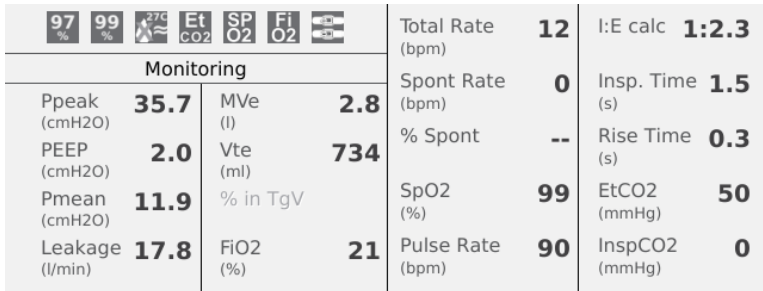

5.3.1 Ppeak

Ppeak displays the highest pressure that is recorded during the inspiratory phase.

5.3.2 PEEP

PEEP displays the pressure at the end of the expiratory phase.

5.3.3 Pmean

Pmean displays the calculated mean value of pressure during a complete ventilatory cycle (inspiratory + expiratory phase).

5.3.4 Leakage

Leakage displays the total leakage (intentional and unintentional) as calculated at expiratory pressure level

5.3.5 MVe

MVe displays the expired Minute Volume calculated as expired Tidal Volume multiplied with the Total Breath Rate.

MVe is displayed when a leakage circuit is used.

5.3.6 MVi

MVi displays the inspired Minute Volume calculated as inspired Tidal Volume multiplied with the Total Breath Rate.

MVi is displayed when an MPV circuit is used.

5.3.7 Vte

Vte displays the Expired Tidal Volume that the patient exhales during each breath.

Vte is displayed when using a leakage patient circuit . Vte is a calculated value.

5.3.8 Vti

Vti displays the inspired Tidal Volume that the ventilator delivers during each breath.

Vti is displayed when an MPV circuit is used.

5.3.9 FiO₂

The FiO₂ displays the fraction of inspired oxygen as measured in the air channel of the ventilator. An FiO₂ sensor needs to be in place to measure and display this value (see the section on using the ventilator with the FiO₂ sensor.)

5.3.10 % in TgV

% in TgV displays the percentage of breaths where the actual delivered Tidal Volume matches with the set Target Volume (not calculated until 100 breaths are registered).

5.3.11 Total Rate

The Total Rate displays the actual total breath rate independent of whether the breaths are patient- or ventilator-triggered breaths.

5.3.12 Spont Rate

The Spont Rate displays the actual spontaneous breath rate.

5.3.13 % Spont

% Spont displays the percentage of spontaneous breaths calculated since the ventilator was last started (not calculated until 100 breaths are registered).

5.3.14 SpO₂ (Oxygen Saturation)

The SpO₂ displays the patient's oxygen saturation, if measured with the SpO₂ module accessory.

- When using the ventilator with the SpO₂ sensor accessory, the ventilator displays functional oxygen saturation measured by the sensor.
- The following information concerns the light emitted by the SpO₂ Sensor:
 1. Peak Wavelength (red): 660 nm
 2. Peak Wavelength (infrared): 905 nm
 3. Maximum Optical Output Power: 15 mW
 4. For more information regarding the oxygen probe's range of peak wavelengths, max optical power and usage, please refer to the respective probe manual.
- Environmental factors may influence the function or accuracy of the pulse oximeter, such as ambient light, physical movement, diagnostic testing, low perfusion, electromagnetic interference, dysfunctional haemoglobin, presence of certain dyes and inappropriate positioning of the pulse oximeter probe.
- A functional test cannot be used to assess the Accuracy of a Pulse Oximeter Probe or a Pulse Oximeter.

5.3.15 Pulse Rate

Pulse Rate displays the patient's pulse rate as measured with the SpO₂ module.

5.3.16 I:E

I:E displays the ratio between the length of the inspiration and the length of the expiration.

5.3.17 Insp. Time

Insp. Time displays the duration of the inspiratory cycle, measured from the start of inspiration to the start of expiration.

5.3.18 Rise Time

Rise Time displays the duration of the pressure or volume increase, measured from the start of inspiration until the set pressure or volume has been reached.

5.3.19 EtCO₂

EtCO₂ displays the end-tidal carbon dioxide, measured on the last portion of the exhaled volume that is passing through the EtCO₂ sensor.

5.3.20 InspCO₂

InspCO₂ displays the inspired carbon dioxide.

5.3.21 PtcCO₂

PtcCO₂ displays transcutaneous CO₂ pressure from an external PtcCO₂ monitor, if connected by the PtcCO₂ cable accessory.

5.4 Modes in the Vivo 45

In the Modes section of the Vivo 45 display, the operator selects the ventilation mode, breath mode, patient mode and device mode for the treatment.

5.4.1 Standby and Operating Mode

Standby mode is defined as the state of the Vivo 45 when it is powered on but without having treatment or pre-use test started.

Operating mode is defined as the state of the Vivo 45 when the blower is operating and producing an air flow.

Switch between operating and standby mode by starting/stopping the ventilator (see 5.1 *Switch the Vivo 45 On and Off*, page 39).

Some operations (such as setting time and date) are only available in standby mode.

5.4.2 Device Mode

The two device modes of the ventilator are used for controlling the user access to the ventilator settings.

Clinical mode allows full access to the ventilator treatment parameters for health care professionals.

Home mode is used to limit the access to the ventilator's settings for patients and lay persons.

If the Home Adjust function is activated, the patient is given the possibility to change a selection of patient parameters that is determined by the responsible care provider. The limited settings for Home Mode are defined in the Setup section



See 5.2.3 *Menu Overview*, page 44 for a chart with settings available in the ventilator's Home Mode.

5.4.3 Patient Mode

The Vivo 45 can be operated in either Adult mode or Paediatric mode.

In Paediatric mode, some ventilator parameters, for example Breath Rate, Inspiratory Time and Target Volume have special setting limits, in order to optimize the treatment for paediatric patients. The settings and alarm limits of the Vivo 45 are reset to default values when the patient mode is altered.

5.4.4 Ventilation and Breath Modes

The ventilation and breath modes are used for controlling the ventilation treatment with the ventilator. The ventilation mode selected can be either Pressure, or CPAP.

Pressure mode is used in combination with the Support, Assist/Control or MPV breath mode.

The following combinations of ventilation and breath modes can be selected for the Vivo 45:

- PSV (Pressure Support Ventilation). May be combined with:
 - TgV (Target Volume)
 - AE (Auto-EPAP)
- PCV (Pressure Controlled Ventilation). May be combined with:
 - A (Assist function — inspiration trigger)
 - TgV (Target Volume)
 - AE (Auto-EPAP)
 - MPV (Mouthpiece Ventilation)
- CPAP (Continuous Positive Airway Pressure)

5.4.4.1 Pressure Support Ventilation (PSV)

In the PSV mode, the patient's spontaneous breathing is assisted by the ventilator. The patient controls the start of inspiration through the inspiratory trigger and the start of exhalation by the expiratory trigger.

The set pressure is used as a target pressure, if the flow is decreased to the expiratory trigger level before the set pressure is reached, the expiration starts.

When an inspiration is started, either when the patient triggers a breath, or when the backup rate setting initiates an inspiration in case of a prolonged Apnea, the ventilator delivers a flow up to a certain preset pressure limit. In case of a patient initiated breath, the patient continues the breath for as long as they wish and cycle off when a percentage drop in peak inspiratory flow (expiratory trigger) has been reached.

Spontaneous breaths stop and an exhalation starts in three cases:

- The inspiration flow has dropped to the value set for expiratory trigger.
- The inspiration time is longer than the limit for maximal inspiration time or when inspiration time reaches 3 seconds.
- The limit for the high-pressure alarm is reached.

5.4.4.2 Pressure Support Ventilation with Target Volume (PSV+ TgV)

The PSV+TgV mode acts as the PSV mode but with an added regulation of the pressure. Target volume is a feature that automatically adapts the pressure to make sure that the Vivo 45 delivers the desired set target volume to the patient. The delivered volume is compared to the set target volume on a breath by breath basis. The delivered pressure for the next breath will be increased or decreased depending on the difference between the delivered volume and the set target volume. Automatic pressure adjustments will be made in between two adjustable limits (min IPAP and max IPAP) in order to deliver the optimal support to the patient



See 5.5.13 *Target Volume*, page 61 for more information about Target Volume.

5.4.4.3 Pressure Controlled Ventilation (PCV)

In the PCV mode the ventilation is controlled by the Vivo 45. This is done at the preset pressure, breath rate, inspiratory time, and rise time settings set by the operator.

The inspiration stops and an expiration starts in two cases:

- The inspiration time expires.
- The limit for the high pressure alarm is reached.

5.4.4.4 Pressure Controlled Ventilation with Target Volume (PCV+TgV)

The PCV+TgV mode acts as the PCV mode, but with an added regulation of the pressure. Target volume is a feature that automatically adapts the pressure to make sure that the Vivo 45 delivers the desired set target volume to the patient. For every breath, the delivered volume is compared to the set target volume. The delivered pressure for the next breath will be increased or decreased depending on the difference between the delivered volume and the set target volume. Automatic pressure adjustments will be made in between two adjustable limits (min pressure and max pressure) in order to deliver the optimal support to the patient.



See 5.5.13 *Target Volume*, page 61 for more information about Target Volume.

5.4.4.5 PCV(A) – Assisted Pressure Controlled Ventilation

In the PCV(A) mode the ventilation is controlled by the ventilator, but the patient has the possibility to start a breath through the Inspiratory Trigger. This patient triggered breath will be delivered with the inspiratory time, rise time and pressure setting set by the operator.

5.4.4.6 PCV(A+TgV) – Assisted Pressure Controlled Ventilation with Target Volume

The PCV(A+TgV) mode acts like the PCV(A) mode, but with an added regulation of the pressure. Target volume is a feature that automatically adapts the pressure to make sure that the ventilator delivers the desired set target volume to the patient. The delivered volume is compared to the set target volume on a breath by breath basis. The delivered pressure for the next breath will be increased or decreased depending on the difference between the delivered volume and the set target volume. Automatic pressure adjustments will be made in between two adjustable limits (min pressure and max pressure) in order to deliver the optimal support to the patient.

5.4.4.7 PCV-MPV– Pressure Controlled MouthPiece Ventilation

Mouthpiece Ventilation

This mode is tailored specifically for those patients that use mouthpiece interface together with pressure controlled ventilation.

It is available in **Adult** patient mode only.

In MPV breath mode it is possible to set Breath Rate to zero so that breaths are only initiated when the patient triggers them using the mouthpiece. The PEEP setting is not available but always set to Off so that no air blows from the mouthpiece when no breath is being delivered.

As the patient is not always connected to the ventilator several of the surveillance functions are not working in the same way as in other modes:

- Disconnection alarm is not available in MPV mode.
- Low Pressure alarm is only active during breaths.
- Apnea alarm is possible to set to longer times and is an important mean of surveillance to make sure that the patient gets ventilation support regularly.

When switching to MPV mode all alarms, except from High/Low Pressure Alarms, are automatically switched off to avoid false alarm triggering (when changing between profiles the alarm settings does not change to Off, but stays as defined in the profiles)

- The alarm levels must be assessed and adjusted considering the patient's condition and treatment settings.
- MPV breath mode shall be used with the mouthpiece circuit including the mouthpiece interface only.
- The MPV circuit including the mouthpiece interface shall be used in MPV breath mode only and is not for use in any other breath mode.
- MPV breath mode shall not be used with ventilator dependent patients.

5.4.4.8 CPAP – Continuous Positive Airway Pressure

In CPAP mode the Vivo 45 is applying a continuous positive pressure to the airways. The flow will automatically be adjusted to maintain the set CPAP level.

5.5 Functions and Parameters in the Vivo 45

The parameters used for controlling the breathing by the Vivo 45 are described below. See also 8.2.3 *Parameter Specifications*, page 126 for detailed parameter data.

Depending on the setup for Home mode adjustment, parameters may not be available or have limited ranges when the Vivo 45 is in Home mode.

5.5.1 **Parameters' Availability in Different Modes**

This table offers an overview of the available parameters in each mode.

Modes Parameter	PSV	PSV (TgV)	PCV	PCV (TgV)	PCV (A)	PCV (A +TgV)	PCV-MPV	CPAP
Insp. Pressure	x		x		x		x	
PEEP	x	x	x	x	x	x		
Auto-EPAP: MIN EPAP MAX EPAP Pressure limit EPAP step Relax Time	x	x	x	x	x	x		
Breath Rate			x	x	x	x		
Insp. Time			x	x	x	x	x	
Backup Insp. Time	x	x						
Ramp	x		x		x			x
Rise Time	x	x	x	x	x	x	x	
Insp. Trigger	x	x			x	x	x	
Exp. Trigger	x	x						
Min Insp. Time	x	x						
Max Insp. Time	x	x						
Backup Rate	x	x					x	
Target Volume: Max Pressure Min Pressure		x		x		x		
CPAP								x

5.5.2 Insp. Pressure

The Insp. Pressure setting is used to define the airway pressure during the inspiratory phase. Minimum/maximum working IPAP is limited/achieved by a software control of blower speed vs. measured pressure.

Unit	Min	Max	Default
cmH ₂ O	4	40	15

5.5.3 PEEP

The PEEP setting is used to define the airway pressure at the end of the expiratory phase.

Unit	Min	Max	Default
cmH ₂ O	2	20 (2)	5 (A) 2 (P)

(2)= The max setting is also limited by Insp. Pressure -2 cmH₂O and Min Pressure -2 cmH₂O.

(A)= Adult mode, (P)= Paediatric mode

5.5.4 Breath Rate

The Breath Rate setting defines the minimum number of breaths the ventilator will deliver as long as no inspiratory trigger effort from the patient is detected. The cycles will be ventilator-initiated breaths.

The combination of the Breath Rate and Inspiratory Time setting is limited by the I:E ratio range 1:9.9 to 2:1.

Unit	Min	Max	Default
1/breath	4 (A) 6 (P)	40 (A) 60 (P)	12 (A) 20 (P)

(A)= Adult mode, (P)= Paediatric mode

5.5.5 Backup Rate

The Backup Rate setting defines the minimum number of breaths the ventilator will deliver as long as no inspiratory trigger effort from the patient is detected. The cycles will be ventilator-initiated breaths.

The combination of the Breath Rate and Inspiratory Time setting is limited by the I:E ratio range 1:9.9 to 2:1.

Unit	Min	Max	Default
breath/ minute	4 (A) 6 (P) 0 (MPV)	40 (A) 60 (P) 40 (MPV)	12 (A) 20 (P) 0 (MPV)

(A)= Adult mode, (P)= Paediatric mode

5.5.6 Insp. Time (Inspiratory Time)

The Inspiratory Time setting defines the length of each inspiration from start of inspiration to cycling off to expiration.

The combination of the Inspiratory Time and Breath Rate settings is limited by the I:E ratio 2:1.

Unit	Min	Max	Default
s	0.3	5 ^(A) 2 ^(P)	1.5 ^(A) 1 ^(P)
(A)= Adult mode, (P)= Paediatric mode			

5.5.7 Backup Insp. Time (Backup Inspiratory Time)

The Backup Inspiratory Time setting defines the length of each inspiration delivered during ventilator-triggered backup ventilation, initiated by the set Backup Rate.

The combination of the Backup Inspiratory Time and Backup Rate setting is limited by the I:E ratio 2:1.

Unit	Min	Max	Default
s	0.3	5 ^(A) 2 ^(P)	1.5 ^(A) 1 ^(P)
(A)= Adult mode, (P)= Paediatric mode			

5.5.8 Rise Time

The Rise Time setting controls the speed of the pressure increase from start of inspiration to set inspiratory pressure.

A low setting will give a faster increase and therefore a longer plateau at the set value. A high setting will give a slower increase and therefore a shorter plateau.

Unit	Min	Max	Default
Step	1	9	3

5.5.9 Insp. Trigger (Inspiratory Trigger)

The inspiratory trigger defines the patient's effort required to initiate a ventilator assisted breath. When the patient starts a breath, an increasing flow is created in the patient circuit. If the patient's effort reaches the set inspiratory trigger level an inspiration is initiated.

If the patient cannot trigger a breath, the ventilator will deliver breaths according to the set Backup Rate or Breath Rate.

Unit	Min	Max	Default
Step	1 ⁽¹⁾	9 Off ⁽²⁾	3 ^(A) 2 ^(P)
(A)= Adult mode, (P)= Paediatric mode (1)= Low value is easy to trigger, high value is harder to trigger. (2)= Off turns off the assisted breath function (Control mode only).			

5.5.10 Exp. Trigger (Expiratory Trigger)

The Expiratory Trigger setting defines the moment when the ventilator will cycle from the inspiratory to the expiratory phase.

Unit	Min	Max	Default
Step	1 ⁽¹⁾	9 ⁽¹⁾	3
(1)= Low value is easy to trigger, high value is harder to trigger.			

5.5.11 Max Insp. Time (Maximum Inspiratory Time)

The Maximum Inspiratory Time setting defines a maximum length for each inspiration. If the Maximum Inspiratory Time is set to Off, the length of the inspiration and/or minimum inspiratory time is dependent on the set Expiratory Trigger.

Unit	Min	Max	Default
s	0.3	5 ^(A) 2 ^(P) Off	Off
(A)= Adult mode, (P)= Paediatric mode			

5.5.12 Min Insp. Time (Minimum Inspiratory Time)

The Minimum Inspiratory Time setting defines a minimum length for each inspiration. If the Minimum Inspiratory Time is set to Off, the length of the inspiration is dependent on the set Expiratory Trigger.

Unit	Min	Max	Default
s	0.3 Off	3 ^(A) 2 ^(P)	Off
(A)= Adult mode, (P)= Paediatric mode			

5.5.13 Target Volume

The Target Volume setting defines the tidal volume that the ventilator will aim for while ventilating the patient in a pressure mode. To aim for the preset volume, the ventilator will adapt the Inspiratory Pressure between two adjustable pressure limits: Min Pressure and Max Pressure.

When Target Volume is active, the mode field on the ventilator display will indicate "(TgV)".

Unit	Min	Max	Default
ml	Off 300 ^(A) 100 ^(P)	2000 ^(A) 500 ^(P)	Off
(A)= Adult mode, (P)= Paediatric mode			

Target Volume Parameters

When target volume is on, the following parameters are enabled:

Max Pressure			
Max Pressure defines the upper pressure limit up to where the ventilator can increase the pressure to reach the set Target Volume. If Target Volume is not reached at Max Pressure, the ventilator will continue to ventilate at this Max Pressure setting.			
Unit	Min	Max	Default
cmH ₂ O	Current <i>Min Pressure</i>	40	15

Min Pressure			
Min Pressure defines the lower pressure limit down to where the ventilator can decrease the pressure to maintain the set Target Volume. If the actual volume is above Target Volume at Min Pressure, the ventilator will continue to ventilate at this Min Pressure setting.			
Unit	Min	Max	Default
cmH ₂ O	4	Current <i>Max Pressure</i>	15

5.5.14 CPAP

The CPAP setting defines the pressure that will be applied to the airways in CPAP mode.

Unit	Min	Max	Default
cmH ₂ O	4	20	10 ^(A) 8 ^(P)

(A)= Adult mode, (P)= Paediatric mode

5.5.15 Ramp Time

The Ramp Time setting defines the time during which the pressure will increase from the set Start Pressure to the set Inspiratory Pressure.

Ramp Time can only be set in Clinical Mode.

Unit	Min	Max	Default
Minute	10 Off	60	Off

5.5.16 Start Pressure

The Ramp Start Pressure defines the pressure level delivered by the ventilator at the beginning of the Ramp Time.

Unit	Min	Max	Default
cmH ₂ O	2	Current <i>Insp. Pressure</i> - 2 or Current <i>CPAP</i>	5

5.5.17 Always Start Ramp

The Always Start Ramp determines whether the ramp is started automatically at the beginning of the treatment.

Unit	Min	Max	Default
—	Off	On	Off

5.5.18 Humidifier

Humidifier allows the user to start or stop the heated humidification.

The click-in water chamber needs to be connected before the setting can be turned On.

Unit	Min	Max	Default
—	Off	On	Off

5.5.19 Humidifier Setting

The Humidifier Setting defines the level of humidity of the air delivered to the patient.

Unit	Min	Max	Default
Step	1	5	3

5.5.20 Heated Circuit Temp

Heated Circuit Temp setting will define the temperature of the heated circuit.

Unit	Min	Max	Default
°C/°F	16/61	30/86	27/81

5.5.21 Circuit Heating

Circuit Heating allows the user to start or stop the heating of the circuit.

The Heated Circuit needs to be connected before the setting can be turned On.

Unit	Min	Max	Default
—	Off	On	Off

5.6 Using Batteries

Since all batteries, in general, degenerate over time, the recommendations below will ensure that the battery capacity of the ventilator is maximized during its lifetime.

The internal and click-in batteries in the ventilator are of the Lithium-ion type, which is a high performance battery. It has long expected lifetime, low weight in relation to its capacity and low self discharge.

5.6.1 Power Source Priority

1. AC power (Mains)
2. External DC
3. Click-in battery
4. Internal battery

When a power source fails, the ventilator will switch to either the external DC (if installed), the click-in battery (if attached) or the internal battery and show a message in the display window.

5.6.2 Power Switchover Tests

This section describes methods for testing the ventilator's switch over from one power source to another.

Internal Battery Switchover Test

Test Conditions

- AC power connected
 - No click-in battery installed
 - Treatment is running
- 1 Disconnect the AC power cord.
 - 2 Check that the:
 - Internal battery power source LED is illuminated
 - Medium priority "Lost Mains Power" alarm is triggered
 - Information message "Switched to Internal Battery" is posted

Click-in Battery Switchover Test

Test Conditions

- AC power connected
 - Click-in battery installed
 - Treatment is running
- 1 Disconnect the AC power cord.
 - 2 Check that the:
 - Click-in battery power source LED is illuminated
 - Medium priority "Lost Mains Power" alarm is triggered
 - Information message "Switched to Click-In Battery" is posted

External DC Switchover Test

Test Conditions

- AC power connected
 - External DC connected
 - Treatment is running
- 1 Disconnect the AC power cord.
 - 2 Check that the:
 - External DC power source LED is illuminated
 - Medium priority "Lost Mains Power" alarm is triggered
 - Information message "Switched to External DC" is posted

5.6.3 Charging the Batteries



CAUTION!

Do not charge the Vivo 45 while placed in the carry bag or other types of closed or non-ventilated spaces.

The internal and click-in batteries are automatically charged when connecting the ventilator to the mains supply. To ensure that the batteries are fully charged, a maintaining charging

cycle will be performed. The batteries are not charged when connecting the ventilator to an external DC supply. While charging, the battery level will be animated. The batteries are only charged if the internal temperatures are between 0 to 45°C (32 to 113°F). High power consuming settings in combination with high ambient temperatures may make the battery temperature rise above 45°C (113°F).



NOTE

Charging of batteries is only started when the state of charge is below 95%

Behaviour of the ventilator while Internal Battery or Click-in Battery is Charging

The ventilator can operate as normal while a battery is charging. The battery icon will be animated (filling in from bottom to top) while charging.

Charging Times

Battery	Charger	Time
Internal battery	Vivo 45	2 h
Click-in battery	Vivo 45	4 h

* Times are based on charging empty batteries.

5.6.4

Battery Icons

When running on battery, the battery status is indicated by the following symbols:

Symbols	Battery Status
	High state of charge (over 50 %)
	Medium State of charge (20 % – 50 %)
	Low state of charge (below 20 %)
	Malfunctioning battery
	Information box displaying state of charge (alters with battery symbol above, when in standby mode)
	Information box displaying estimated remaining treatment time (alters with battery symbol above, when in treatment mode)

5.6.5 Internal Battery

The internal battery is intended as a backup power source if the primary power source fails. It can also be used as a temporary power source. For example during transportation between one stationary power source to another.

5.6.6 Click-in Battery

The click-in battery is intended as a power source during transportation, or if the primary AC power source fails.

The click-in battery can be replaced during treatment, provided that the internal battery is charged.

Connect the Click-in Battery

1 Release the side cover by pressing the button under the handle.

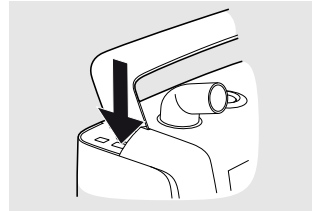

2 Open and remove the side panel.

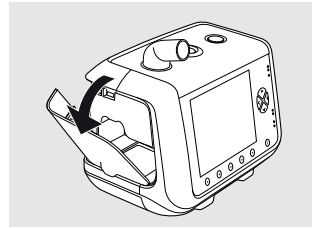

3 Insert the click-in battery. Make sure the latch at the bottom of the click-in compartment is engaged.

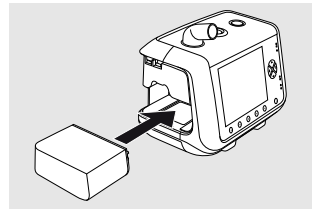

4 Close the side panel. Make sure there is a clicking sound to secure the side panel.

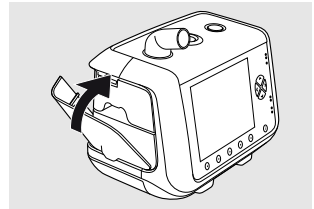

When removing the battery, press down the latch at the bottom of the battery compartment and tilt the ventilator sideways. Make sure to close the side panel after removing the click-in battery.

5.6.7 Battery Operating Time (Internal and Click-in)

The operation time is dependent on the battery condition, its capacity, the ambient air temperature and the ventilator pressure setting. These data are based on new and fully charged batteries.

Condition	Value
Environmental Conditions	
Ambient temperature	20°C (68°F)
Ventilator settings	
Mode	PCV
Pressure*	20 cmH ₂ O
PEEP	4 cmH ₂ O
Breath Rate*	20 bpm
Insp. Time*	1.0 s
I:E	1:2
Insp. Trigger	Off
Rise Time	1
Target Volume	Off
Display Light*	Off
Light Intensity*	-
Other	
Tidal Volume	800 ml
Resistance	5 hPa (l/s) ⁻¹
Compliance	50 ml (hPa) ⁻¹

*: These ventilator settings affect the operating time significantly.

Battery	Operating Time
Internal Battery	2.5 h
Click-in Battery	6.5 h

5.6.8 Storing the Internal Battery and the Click-in Battery

Storage longer than 1 month should be initiated with half-charged batteries in order to maintain maximum capacity. Optimal storage temperature is 5 to 30°C (41 to 86°F).

5.6.9

External DC



WARNING!

Do not connect the Vivo 45 to a wheelchair unless the operating manual for the wheelchair permits this as this can affect the Vivo 45 performance and consequently result in patient death.

The ventilator can be operated from:

- The Breas XPAC using the XPAC battery cable.
- A 12 V external DC source using the 12-24 VDC car adapter cable.
- A 24 V external DC source using the external battery cable.
- Both AC power supply and external DC using the Y-cable.

With both AC power supply and external DC source connected, the ventilator will automatically switch over to the external DC source if the AC power supply fails. The external DC voltage level is shown under “Others”, “Device Information” in the menu

1 Connect the external DC cable to the ventilator.
Make sure that it is fitted correctly.

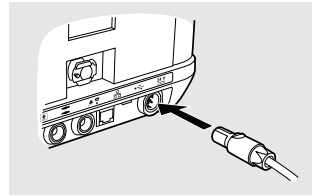

2 Connect the other end of the cable to the DC source.

5.7 Using Accessories

5.7.1 Connecting and Disconnecting the Cables

- 1 Insert the cable in the appropriate port.
- 2 Make sure to insert the connector with the marking pointing upwards.

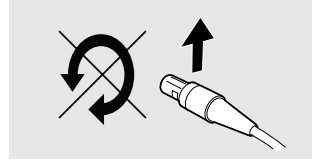
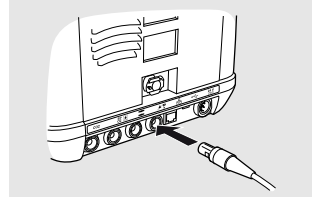

- 3 Pull the connector sleeve, not the cable itself or cable restrainer to release the connector.

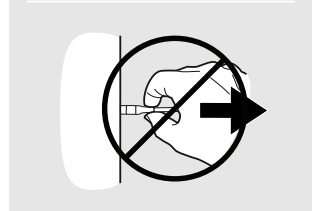
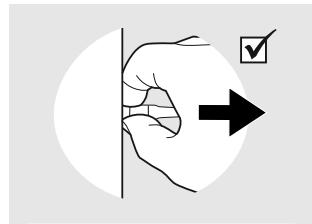

5.7.2 Using the ventilator with a Nurse Call System

The ventilator can be connected to a nurse call system using the nurse call cable. When connected, the ventilator alarms will also be forwarded to the nurse call system.

5.7.2.1 Connect the ventilator to a Nurse Call System

- 1 Connect the nurse call cable at the back of the ventilator.

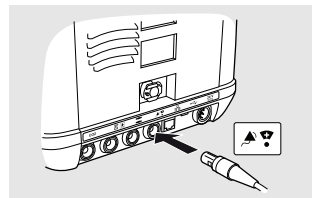

- 2 Test the connection by triggering an alarm on the ventilator and verify that the nurse call system activates.

5.7.3 Using the ventilator with the FiO₂ Sensor

The FiO₂ sensor can be used to monitor and store FiO₂ measurements. The FiO₂ sensor measures the fraction of inspired oxygen in the air channel of the ventilator. The FiO₂ measurements will be stored in the data memory which can be downloaded to a PC and viewed in Breas software.

Usage	Time
Operating temperature	10 to 40°C (50 to 104°F)
Operating pressure	700 to 1250 mbar
Expected operating life	<3 years (in ambient air) or 500,000 Vol.% h, whichever comes first.
Shelf life	< 6 months (recommended)



CAUTION!

Note that the operating conditions for the FiO₂ sensor is different from the ventilator system conditions. If the sensor is used outside its operating conditions the FiO₂ measurements might deviate.

5.7.3.1 Installing the FiO₂ Sensor

- 1 Place the ventilator so the bottom is accessible.
- 2 Remove the hatch for FiO₂ sensor. Use a torx TX10 screwdriver.

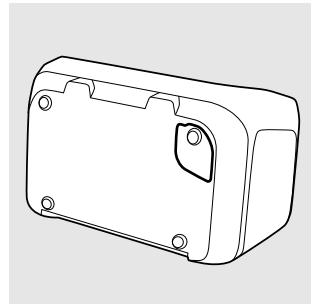

- 3 Insert the FiO₂ sensor with the electrical contact side in.

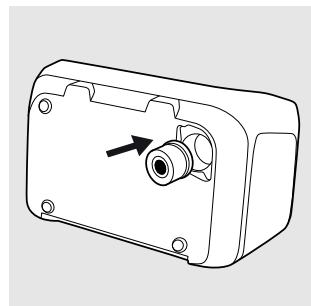

- 4 Reinstall the hatch.
- 5 Calibrate the FiO₂ sensor in the advanced settings of the main menu.



When installed, the ventilator automatically detects the sensor, also after powering off/on and after power failure.

5.7.3.2 Calibrating the FiO₂ sensor

The FiO₂ sensor should be calibrated when first used and then at least once a month.



FiO₂ calibration can be performed from the “FiO₂/CO₂ Calibration” page under the Advanced settings section of the main menu.

5.7.4 Using the ventilator with the Remote Alarm



Information about safety, warnings, product description, installation, usage, cleaning, maintenance and technical specifications can be found in the user instruction for Remote Alarm.

The Remote Alarm enables care providers and clinical personnel to monitor the ventilator alarms remotely. The Remote Alarm forwards alarms from the ventilator. When an alarm sounds, the care provider or clinical personnel must attend to the patient quickly.

When installing a remote alarm system, check that it operates as intended before starting the treatment.

5.7.5 Using the ventilator with the EtCO₂ Sensor

The EtCO₂ sensor can be connected to the patient breathing circuit and to a Vivo 45 in order to monitor and store CO₂ measurements. The CO₂ measurements will be stored in the ventilator data memory which can be downloaded to a PC and viewed in the ventilator PC software.



More information about safety, warnings, product description, installation, usage, cleaning, maintenance and technical specifications can be found in the user instruction for the EtCO₂ sensor.

5.7.5.1 Safety Information

WARNING!



Read the instructions thoroughly so that you completely understand how the EtCO₂ sensor is operated before taking it into use, to ensure correct usage and maximum performance.

Breas Medical reserves the right to make changes to this product without any prior notification.



Do not use a damaged CO₂ sensor or adapter.

The CO₂ sensor is intended to be used by authorized and trained medical personnel only.



The CO₂ sensor is intended only as an adjunct in patient assessment. It must be used in conjunction with other assessments of clinical signs and symptoms.



Masks' dead-space, patient's volumes and unintentional leakage may influence the CO₂ measurements.



Used airway adapters shall be disposed of in accordance with local regulations for medical waste.



Measurements can be affected by mobile and RF communications equipment. It should be assured that the CO₂ sensor is used in the electromagnetic environment specified in 8.3 *Emission and Immunity Declaration*, page 133.

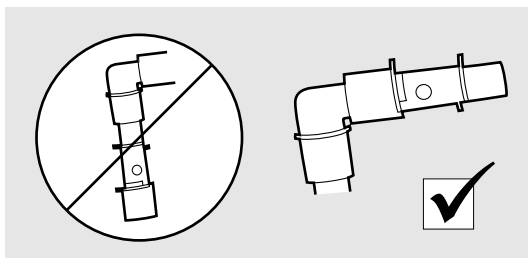

Do not place the airway adapter between the endotracheal tube and an elbow as this may allow patient secretions to block the adapter windows and result in incorrect operation.



Incorrect CO₂ zeroing will result in false gas readings.
Replace the airway adapter if rain-out/condensation occurs inside the airway adapter.



Only use airway adapters distributed by Breas Medical.
Do not apply tension to the CO₂ sensor cable.



To keep secretions and moisture from pooling on the windows, always position the CO₂ sensor in a vertical position with the green LED pointing upwards.



WARNING!

Disposable airway adapters shall not be reused. Reuse of the single use adapter can cause cross infection.



CAUTION!

If an intentional leakage port is used, make sure that the CO₂ sensor is placed between the patient interface and the leakage port.
If a patient interface with integrated leakage is used, the monitored CO₂ values may be influenced.



The CO₂ sensor should be placed as close to the patient interface as possible. However, a HME (if used) shall be placed between the patient interface and the CO₂ sensor. This will protect the airway adapter from secretions and effects of water vapour and eliminates the need of changing the airway adapter.



NOTE

The CO₂ monitoring automatically compensates for changes in ambient barometric pressure. The CO₂ monitor shall fulfil the ISO 80601-2-55 standard (Medical electrical equipment – Particular requirements for the basic safety and essential performance of respiratory gas monitors).

5.7.5.2 How to Connect the EtCO₂ Sensor



WARNING!

The CO₂ sensor is not intended to be in contact with the patient body.

1 Connect the CO₂ sensor cable to the CO₂ connection port on the ventilator (according to the instruction 5.7.1 *Connecting and Disconnecting the Cables*, page 69).

A green LED indicates that the CO₂ sensor is ready to use.

2 Snap the CO₂ sensor probe on top of the airway adapter. It will click into place when properly sealed.

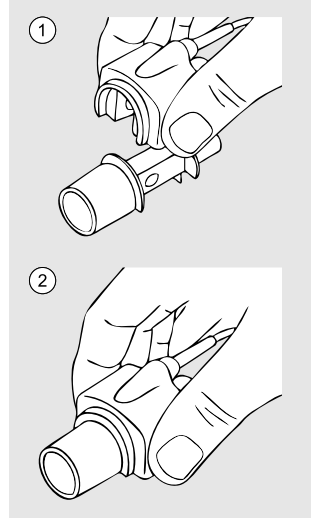

3 Perform a CO₂ zeroing procedure.

4 Connect the airway adapter to the patient circuit.

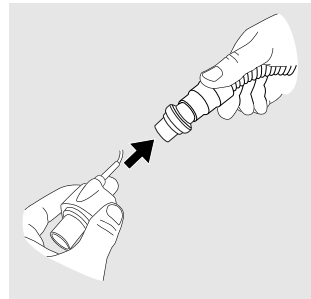

5 Make sure to position the CO₂ sensor with the LED pointing upwards.

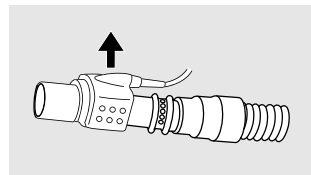

When installed, the ventilator automatically detects the sensor, also after powering off/on or after power failure.

CO₂ Zeroing

CO₂ zeroing is recommended when changing the airway adapter. Besides from that, zeroing only needs to be performed when an offset in monitored CO₂ values is observed, or when a CO₂ sensor accuracy unspecified message is displayed.

LED Status	Description
Steady green light	System OK
Flashing green light	Zeroing in progress
Steady red light	Sensor error
Flashing red light	Check adapter

Maintenance

No periodical maintenance is required for the CO₂ sensor.

To verify the CO₂ sensor readings, a gas span check shall be performed every year, preferably when the ventilator is sent for service.



See the ventilator service manual for how to perform the gas span check.



WARNING!

Do not under any circumstances attempt to service or repair the CO₂ sensor yourself. If you do so, the manufacturer will no longer be responsible for the performance and safety of the CO₂ sensor.



Cleaning

WARNING!

- Always be careful when cleaning to ensure that you do not damage any equipment.
- Fluid must not be allowed to enter into the CO₂ sensor.
- Always clean the T-piece with plug when to be used by a new patient. All parts that come into contact with the respiration gas must be cleaned.
- Remove the airway adapter before cleaning.
- Do not sterilise the CO₂ sensor.
- Do not autoclave the CO₂ sensor.



Clean the outside of the CO₂ sensor using a lint-free cloth moistened, but not wet, with ethanol or isopropyl alcohol (< 70%).

Disposal

The CO₂ sensor must be disposed of in accordance with the local environmental regulations regarding the disposal of used equipment and waste.

5.7.6 Using the ventilator with the PtcCO₂ Cable

An external monitor for Transcutaneous CO₂ Pressure (PtcCO₂) may be connected to the ventilator by an accessory PtcCO₂ cable. For information about available PtcCO₂ cables, see 9 *Accessories and Parts*, page 139.



NOTE

Both the PtcCO₂ cable and the EtCO₂ sensor connects at the ventilator's yellow CO₂ port. Only one CO₂ measuring device can be connected at a time.

When connected, the ventilator will:

- Display the monitored values and include them in trend views.
- Store monitored values in the internal memory. The PtcCO₂ values will also be included in the data that can be downloaded and analysed with Breas PC software.
- Repeat CO₂ alarms from the external PtcCO₂ monitor.
- Automatically detect the sensor, also after powering off/on or after power failure

5.7.7 Using the Ventilator with the SpO₂ module



Information about safety, warnings, product description, installation, usage, cleaning, maintenance and technical specifications can be found in the user instruction for SpO₂ module.

The SpO₂ module enables connection to an SpO₂ sensor for measuring of functional oxygen saturation of arterial haemoglobin (SpO₂) and pulse rate. The SpO₂ module can be connected to the Vivo 45 in order to monitor and store SpO₂ measurements.

The SpO₂ measurements will be stored in the data memory which can be downloaded to a PC and viewed in the Breas PC software.

When installed, the Vivo 45 automatically detects the sensor, also after powering off/on and after power failure.

5.7.8 Using the Ventilator with the Effort Belts



NOTE

The effort belt communication box and the Remote Start/Stop use the same port on the ventilator. Only one of the accessories can be connected at a time.

The Effort Belt Communication Box

Up to two effort belts may be connected to the ventilator by the accessory Effort belt communication box.

When the effort belt communication box is connected, the ventilator will:

- Perform a start up test when an effort belt is connected.
- Check the effort belt unit for internal failures.
- Include real time wave forms from the effort belts on the Effort monitoring page.
- Store the effort belt measurements in the internal memory. The effort belt measurements will also be included in the data that can be downloaded and analysed with Breas PC software.
- Automatically detect the belt, also after powering off/on or after power failure

Connecting the Effort Belt

- 1 Connect the black pins of the wire set to the effort belt.
- 2 Connect the key-shaped connector of the wire set to the communication box.
- 3 Connect the Effort belt communication box to the ventilator.

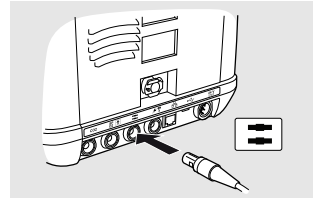

Effort Belt Connection Status

The connection status of the effort belts are indicated by LEDs on the effort belt communication box and by the effort belt symbol on the display

Status	Indication
Connection OK	<ul style="list-style-type: none">• Communication box Green LED for each effort belt.• Vivo 45 Display White belts in the effort belt symbol.
Communication box connected but not belt	<ul style="list-style-type: none">• Communication box Red LED for unconnected belt. Green LED for connected belt.• Vivo 45 Display White belt in the effort belt symbol for connected belt. Red belt in the effort belt symbol for unconnected belt.
Communication box not connected	<ul style="list-style-type: none">• Communication box No light from LEDs.• Vivo 45 Display No effort belt symbol.

5.7.9 Using the ventilator with the Remote Start/Stop



NOTE

The effort belt communication box and the Remote Start/Stop use the same port on the ventilator. Only one of the accessories can be connected at a time.

5.7.9.1 Connecting the Remote Start/Stop

1 Connect the Remote Start/Stop cable to the ventilator.

Information about safety, warnings, product description, installation, usage, cleaning, maintenance and technical specifications can be found in the user instruction for Remote Start/Stop.

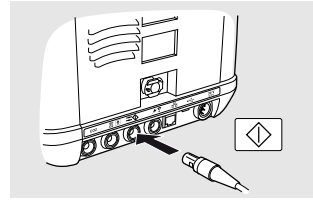

5.7.10 Using the ventilator with the Protective Cover

The protective cover is intended for additional protection of the ventilator during transportation, and in hospital, institutional and home care environments. It can be used while the ventilator is operating, for example mounted on a wheelchair, in a personal vehicle, or carried by hand.

The protective cover protects the ventilator from environmental impact such as shock, water spill, sunlight, dust and dirt, under normal handling.

The protective cover has the following functions:

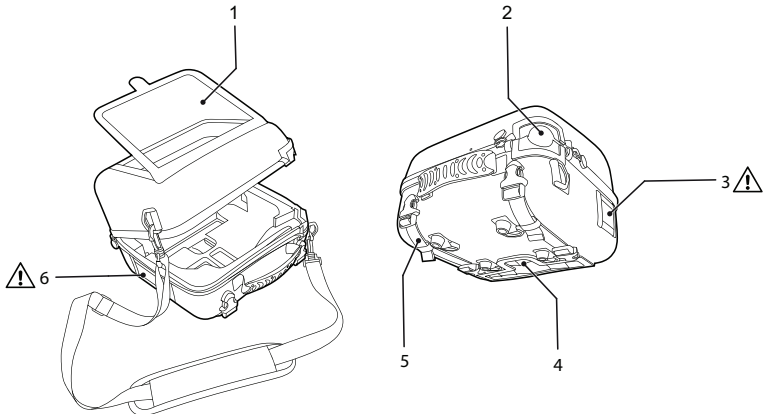

1. Transparent window, for accessing front panel and buttons
2. Port for patient circuit
3. Cooling air inlet
4. Port for cables and O₂ inlet
5. Mounting straps
6. Patient air inlet

CAUTION!

Do not cover the air inlets or outlets.



5.7.11 Using the Vivo 45 with the Trolley

Intended Use

The intended use of the trolley system is to allow patient mobility while receiving ventilator treatment. The trolley shall only be used in indoor, hospital environment. The trolley system consists of a trolley base and a mounting bracket.

This section describes how to use the Vivo 45 and a trolley with mounting bracket.

Mount and dismount the Vivo 45 as shown in the picture:

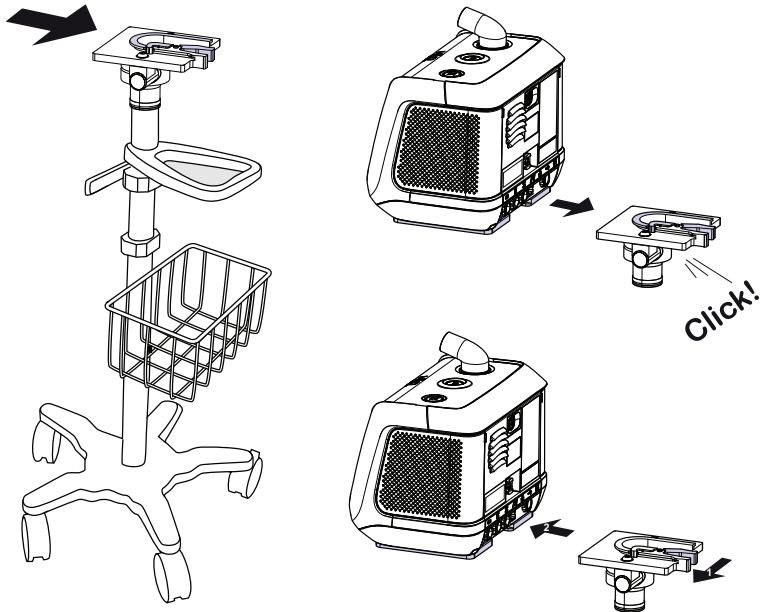

The bottom plate is mounted to the trolley using two screws.

Be careful when handling the trolley with the ventilator mounted, in order to avoid any risk of the trolley falling. The trolley can be tipped 10° and return to vertical position, when loaded in accordance with the weight specifications below.

WARNING!

The maximum total weight of the trolley and added accessories is 37 kg (82 lbs). (Trolley base weight = 12 kg (26 lbs), maximum externally added load = 25 kg (55 lbs).)

- The maximum load of the trolley basket is 0.9 kg (2 lbs).
- The maximum load of the IV-pole is 3 kg (6.5 lbs).
- The maximum load of the trolley rail is 9 kg (20 lbs).
- The maximum load of the E-cylinder holder is 7.9 kg (17.5 lbs).

No maintenance is required.

5.7.12 Using the Click-in Humidifier

WARNING!

Read the chapter 2.6 *Humidification*, page 18 before using the Vivo 45 with the humidifier.



CAUTION!

The click-in humidifier and the circuit heating operates on the AC power source only. If the AC power source fails and the internal or the external battery activates, the click-in humidifier and the circuit heating will be turned off automatically.

The click-in humidifier is intended to humidify the patient air. It is intended for non-invasive use only. The click-in water chamber is for single patient use only. Reusing a water chamber for a new patient might cause a risk of cross-contamination. The Vivo 45 shall not be moved with a filled water chamber installed.

About the Click-in Humidifier

The information in the table below is applicable to the recommended breathing system configuration, which is the click-in humidifier and the heated circuit.

Property	Value
Humidifier classification	ISO 80601-2-74:2021, Class 2
Rated Flow	Max 50 l/min
Operating Conditions	+5°C to +40°C. Humidity: max 90% RH, non-condensing.
Max humidification output	> 10 mg/l
Duration of Operation between Humidifier refills	Default setting (3): 16 hours and 40 minutes Max setting (5): 8 hours and 40 minutes
Static temperature stability *	±2°C
Measurement uncertainty	±0.5°C

* The static temperature stability have been measured at the patient port, when using the attachable humidifier. The measurement conforms to ISO 80601–2–74:2021 and discloses the value for the worst case breathing gas pathway configuration.

5.7.12.1

Adding Water to the Water Chamber

CAUTION!

Use only distilled or sterilised water or boiled, chilled tap water in the humidifier water chamber. This is to reduce mineral deposits and maximize the life of the water chamber.

Do not fill the water chamber with hot water.

Do not overfill the water chamber. Fill only the water chamber to the maximum level indicated on the water chamber.

Always ensure the lid with seal is properly mounted after filling and reassembling the water chamber. Also check that the water chamber is correctly docked in place and locked to the ventilator.





Avoid to remove the seal from the lid at normal, daily usage.



Make sure all parts are dry before the ventilator is connected to the mains and put into operation.

- 1 Detach the water chamber, see 5.7.12.4 *Detaching the Water Chamber*, page 82.
- 2 Inspect the water chamber for damages, dirt or deposits. Clean if required, see 5.7.12.6 *Cleaning the Water Chamber*, page 83. If the water chamber is damaged, replace it before use.
- 3 Fill water to the chamber, by filling through one of the airway connections.

Make sure not to fill above the Max indication. A water chamber filled to the maximum level contains approximately 350 ml

You can also remove the lid and fill water through the top of the chamber.

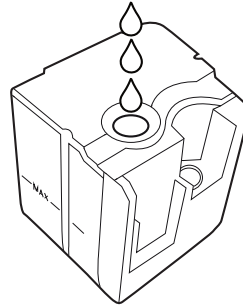

5.7.12.2 Installing the Water Chamber



CAUTION!

Do not switch on the humidifier without a filled water chamber in order to avoid burn or damage to the humidifier's electronics.



NOTE

If the ventilator is equipped with click-in battery, remove it before installing the water chamber.

Follow the instructions in the illustration below to install the water chamber to the ventilator

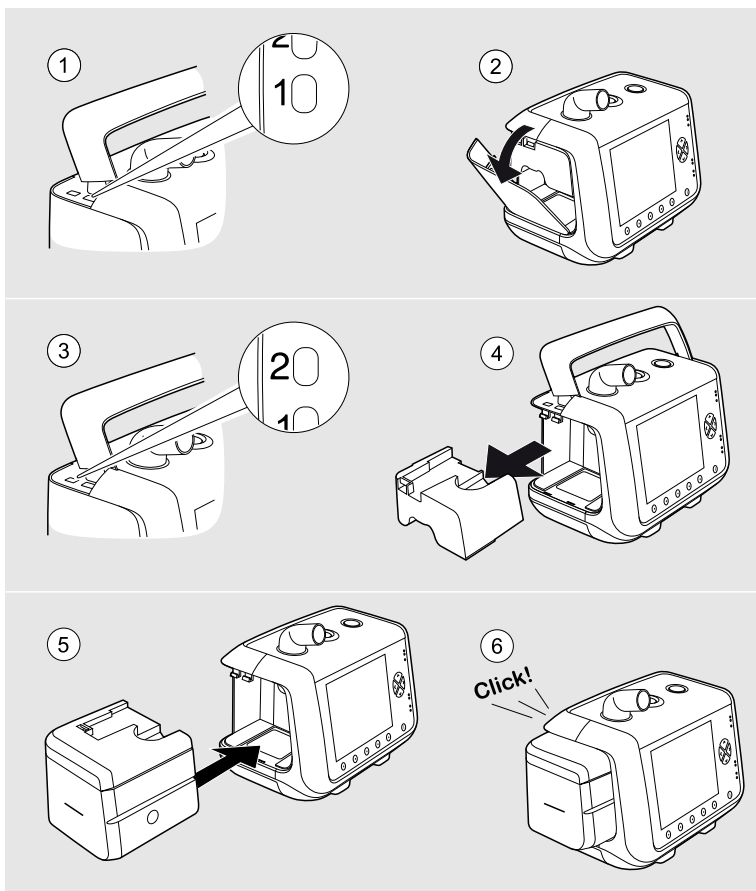

CAUTION!

Always make sure the water chamber is in correct position before use.
Store the airway bypass unit in a clean and dust free environment.

5.7.12.3 Activating the Humidification

The water chamber must be installed in order to access the humidifier setting on the ventilator menu, both in clinical and home mode. If the water chamber is disconnected and reconnected after usage, the ventilator will remember the humidity setting used.

The click-in humidifier only operates during treatment. When the ventilator is in standby mode, the humidification is paused.

Prerequisites

- The water chamber shall be filled with water and attached.
- The ventilator shall be connected to the mains power supply

1. On the **Others** page, select **Heat/Humidity Settings**.
2. Select **Humidifier Setting** and set the level of humidification. 1 is the lowest level 5 is the highest level.
3. Select **Humidifier** and set it to **On**.
4. The humidifier is now activated and will start to operate when the treatment starts.

5.7.12.4 Detaching the Water Chamber

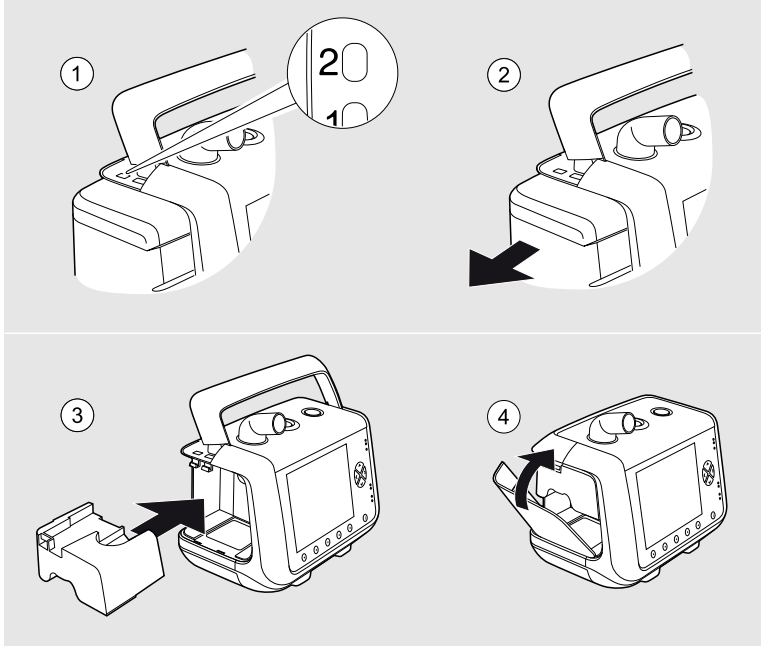

CAUTION!

Always insert the air bypass unit after disconnecting the water chamber.



WARNING!

Always stop treatment before detaching or attaching the water chamber. Make sure the Vivo 45 with the attached water chamber is placed lower than the patient and on a flat surface. This is to prevent personal injury from accidental spillage or from excess water or condensation flowing down the patient tube and into the patient's interface.



Never add or pour out water from the water chamber when it is attached to the ventilator.
If there is water outside of the water chamber after filling, dry it using a lint-free cloth before reconnecting it to the ventilator.



WARNING!

To avoid burn injury, be careful not to touch the heater plate or the heated water in the water chamber when the humidifier is switched on or has not yet cooled down. Wait 10 minutes for the heater plate and water to cool.

5.7.12.5 Opening the Water Chamber

The water chamber lid shall be opened when manually emptying or cleaning the water chamber

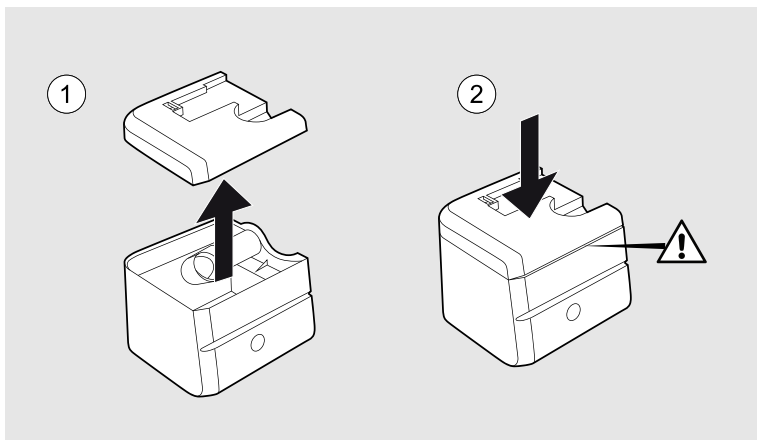

CAUTION!

Always make sure the lid of the water chamber is totally sealed.

5.7.12.6 Cleaning the Water Chamber

The cleaning and disinfection intervals should be established by the care provider, based on the care provider's infection control procedures.

- 1 Open the water chamber as described in 5.7.12.5 *Opening the Water Chamber*, page 83.
- 2 Clean the parts of the water chamber either by hand using a mild detergent or in a dishwasher without dishwashing detergent. Max. temperature: 60°C (140°F).
- 3 If there are mineral deposits inside the water chamber, dissolve them using warm water and citric acid for 30 minutes.

For disinfecting the water chamber, use any of the agents listed below. Follow the provider's instructions. The water chamber will withstand at least 20 disinfections without degradation.

Disinfection Agent	Duration
Gigasept® FF 5% solution	15 minutes
Steranios 2% solution	10 minutes

5.7.13 Using the Patient Circuit with Heated Wire

The ventilator may be used with the accessory *Patient Circuit, Heated Wire with Cable Connector*.

When the heated circuit is used, the time for the patient air temperature to reach the set temperature from a starting temperature of $(23\pm 2)^{\circ}\text{C}$ may be up to 3 minutes.

Prerequisites

The wire heating only operates during treatment. When the ventilator is in standby mode, the wire heating is paused.



Read the User Instruction for the Patient Circuit, Heated Wire with Cable Connector before using the patient circuit.

5.7.13.1 Connecting the Patient Circuit

Connect the circuit as described in 4.4 *Connecting the Patient Circuit*, page 34.

When the circuit is connected, continue with activating the circuit heating.

5.7.13.2 Activating the Circuit Heating

The ventilator shall be connected to the mains power supply

- 1 On the **Others** page, select **Heat/Humidity Settings**.
- 2 Select **Heated Circuit Temp** and set the temperature according to the respiratory therapist's prescription.
- 3 Select **Circuit Heating** and set it to **On**.

The circuit heating is now activated and will start to operate when the treatment starts.

6

Alarms



WARNING!

The adjustable alarm settings should be re-evaluated whenever a change in settings is made on the ventilator.



CAUTION!

Never leave a patient unattended during an alarm condition.

Setting alarm limits to extreme values could put the patient at risk.

Permitted distributed alarm systems are Vivo 45 remote alarm with cable and Vivo 45 nurse call cables provided by Breas Medical only.



NOTE

The alarm settings are maintained during an extended power failure.

This chapter describes the alarm functions used for the ventilator.

6.1

Alarm Function

The alarm function of the ventilator consists of the alarm LEDs on the front panel, an audible alarm, and messages on the display (see the front panel section for an overview of the position of the LEDs).

6.1.1

Alarm Indication

As soon as an alarm condition is detected, the ventilator main unit and the remote alarm unit (if connected) will alarm without delay.

When an alarm condition arises, the alarm is indicated in three ways:

Colour LED on the panel

Indicates the priority of the active alarm condition.

- High priority: red colour, flashing twice per second.
- Medium priority: yellow colour, flashing every 2 seconds.

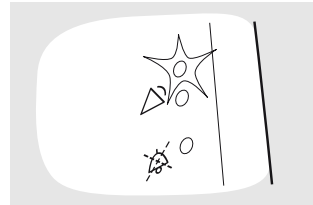

Alarm text in display

Displays the name of the active alarm condition.

If several alarm conditions have been reached, the alarm descriptions are rolling in the display, displaying the alarms with highest priority first. A “>>” symbol is indicating that more than 1 alarm is set.

For detailed information about an alarm, press the info button at the lower left corner of the front.

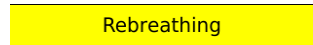

Audible signals

- **High priority:** 3 signals followed by 2 more. The signal sequence is repeated with a 0.5 second pause and thereafter a 3 second pause.



- **Function failure:** Same signal as the high priority alarm or a constant signal, depending on the kind of function failure.

- **Medium priority:** 3 signals, with a lower frequency than the high priority alarm. The signal sequence repeats after a 6 second pause.



- **Information:** 1 signal with a low frequency. The signal is repeated after a 5 second pause and stopped after 5 second sequences.



The power failure alarm sounds in the case of power failure.

If the external DC falls below the warning limit and it is the last power source, the Low External DC warning is displayed.

If a battery that is the last power source falls below the warning limit, the Low Last Power Source alarm is set.

6.1.2 Audible Signal Pause

The audible signal of an active alarm can be paused for 60 seconds by pressing the Audio Pause button. The audible signal can be reactivated by pressing the Audio Pause button again.

If a new alarm condition occurs during the audio pause period, the audible signal will be reactivated.

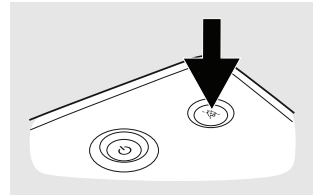

6.1.3 Audible Signal Presilence

The audible signal can be turned off for the coming 2 minutes.

CAUTION!

During the presilence period, any new alarms will only be indicated by the visual signals, the audible signal will not be activated.



NOTE

Power Failure and Function Failure alarms are not affected by presilence and, if triggered, will sound during the presilence period.



- 1 Press and hold the Audio Pause button for about 3 seconds.

⇒ A confirmation request is displayed.

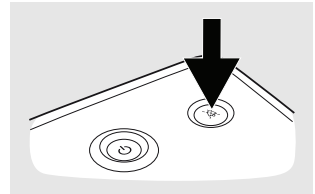

- 2 Press OK to confirm.

6.1.4 Alarm Reset

An alarm will automatically be reset once the cause of the alarm has been corrected.

In the alarm descriptions, read the *Possible cause* information and perform corrective actions, if applicable.



WARNING!

If an alarm condition cannot be corrected, discontinue use and refer the ventilator for service.

6.2 Operator's Position

To receive the audible part of an alarm, the operator's position should be within audible range from the ventilator, depending on the set audible alarm level.

To receive the visual part of an alarm and its priority, the operator's position should be within a distance of 4 metres (13 feet) from the ventilator, and within an angle of 30° to the normal of the ventilator display.

6.3 Physiological Alarms

The ventilator only enables the alarms that are relevant for the used treatment. If changing modes or treatment settings, review the alarm settings.

6.3.1 High Pressure Alarm

Property	Description
Alarm text	High Pressure
Priority	High
Alarm condition	A High Pressure alarm will be given when the patient pressure reaches the set High Pressure alarm limit for three consecutive breaths. It will also be given if pressure exceeds 75 cmH ₂ O.
Possible cause	<ul style="list-style-type: none"> • Mismatch between pressure setting and alarm setting. • Coughing during inspiration. • Changes in airway resistance and or compliance.
Reset criteria	A full breath is performed with maximum pressure below the alarm limit.
Ventilator action	The Vivo 45 will continue treatment according to the current settings. The actual breath is however terminated if the High Pressure alarm limit is reached.
Setting range	<ul style="list-style-type: none"> • 5 cmH₂O to 55 cmH₂O <p>Note that the High pressure alarm cannot be set lower than the value set for the Low pressure alarm.</p>
Setting resolution	Below 10 cmH ₂ O: 0.5 cmH ₂ O Above 10 cmH ₂ O: 1.0 cmH ₂ O
Setting Display	The High Pressure alarm setting is displayed by a red line in the pressure bar graph.

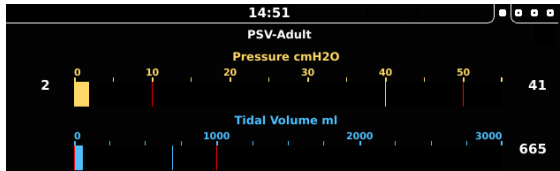

6.3.2

Low Pressure Alarm

Property	Description
Alarm text	Low Pressure
Priority	High
Alarm condition	A Low Pressure alarm will be given when the Vivo 45 pressure fails to reach the low pressure alarm limit for 15 seconds. The low pressure alarm is disabled during ramp periods.
Possible cause	<ul style="list-style-type: none"> • Disconnection of patient circuit. • Mismatch between pressure setting and alarm setting. • Leakage from the mask or other components of the patient circuit.
Reset criteria	The pressure rises above the alarm limit.
Ventilator action	The Vivo 45 will continue treatment according to the current settings.
Setting range	<ul style="list-style-type: none"> • 1 cmH₂O to 40 cmH₂O <p>Note that the Low pressure alarm cannot be set higher than the value set for the High pressure alarm.</p>
Setting resolution	Below 10 cmH ₂ O: 0.5 cmH ₂ O Above 10 cmH ₂ O: 1.0 cmH ₂ O
Setting display	The Low Pressure alarm setting is displayed by a red line in the pressure bar graph.

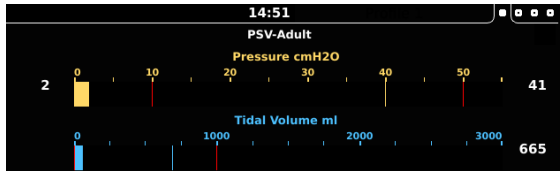

6.3.3 High PEEP Alarm

Property	Description
Alarm text	High PEEP
Priority	Medium
Alarm condition	A High PEEP alarm will be given when the measured PEEP is 30% above the set value for more than 15 seconds
Possible cause	<ul style="list-style-type: none">Blocked leakage port.Too short expiratory time.Changes in airway resistance and or compliance.
Reset criteria	PEEP has gone below the alarm limit (lower than 30% above the set value).
Ventilator action	The Vivo 45 will continue treatment according to the current settings.
Setting range	<ul style="list-style-type: none">OnOff

6.3.4 Low PEEP Alarm

Property	Description
Alarm text	Low PEEP
Priority	Medium
Alarm condition	A Low PEEP alarm will be given when the measured PEEP is 30% below the set value for more than 60 seconds
Possible cause	<ul style="list-style-type: none">Excessive leakage.
Reset criteria	PEEP has gone above the alarm limit (higher than 30% below the set value).
Ventilator action	The Vivo 45 will continue treatment according to the current settings.
Setting range	<ul style="list-style-type: none">OnOff

6.3.5 High Vt_i (High Inspired Tidal Volume Alarm)

Property	Description
Alarm text	High Vt_i
Priority	Medium
Alarm Condition	A High Inspired Tidal Volume alarm will be given when the monitored Inspired Tidal Volume exceeds the set limit for the High Inspired Tidal Volume alarm for 15 seconds.
Possible cause	<ul style="list-style-type: none">• Mismatch between Inspired Tidal Volume and alarm setting.• Pressure settings causing the Inspired Tidal Volume to exceed the set alarm level.• Leakage from the mask or other components of the patient circuit.
Reset criteria	When inspired tidal volume is below set alarm limit
Setting range	<ul style="list-style-type: none">• 150 ml to 2500 ml• Off
Setting resolution	10 below 600 ml, 100 above 600 ml
Ventilator action	The ventilator will continue treatment with the same settings.

6.3.6 Low Vt_i Alarm (Low Inspired Tidal Volume)

Property	Description
Alarm text	Low Vt_i
Priority	High
Alarm Condition	A Low Inspired Tidal Volume alarm will be given when the monitored Inspired Tidal Volume fails to reach the set limit for the Low Inspired Tidal Volume alarm for 15 seconds.
Possible cause	<ul style="list-style-type: none">• Mismatch between Inspired Tidal Volume and Alarm setting.• Changes in airway resistance and or compliance.
Setting range	<ul style="list-style-type: none">• 100 ml to 2000 ml• Off
Setting resolution	10 below 600 ml, 100 above 600 ml
Reset criteria	A full breath above set alarm limit
Ventilator action	The ventilator will continue treatment with the same settings.

6.3.7

High MV_i Alarm (High Inspired Minute Volume Alarm)

Property	Description
Alarm text	High MVi
Priority	Medium
Alarm condition	A High Inspired Minute Volume alarm will be given when the monitored inspired minute volume exceeds the set limit for 15 seconds.
Possible cause	<ul style="list-style-type: none">• Mismatch between Breath Rate, Inspired Tidal Volume settings and the alarm setting.• Increased Breath Rate.• Leakage around the mask or within one of the components of the circuit.
Reset criteria	When inspired minute volume is below set alarm limits
Setting range	<ul style="list-style-type: none">• 1.0 to 40 l/min• Off
Setting resolution	0.5 l/min
Ventilator action	The ventilator will continue treatment with the same settings.

6.3.8

Low MV_i (Low Inspired Minute Volume Alarm)

Property	Description
Alarm text	Low MVi
Priority	High
Alarm condition	A Low Inspired Minute Volume alarm will be given when the monitored minute volume does not reach the alarm limit for 15 seconds.
Possible cause	<ul style="list-style-type: none">• Mismatch between Breath Rate and Inspired Tidal Volume settings and the alarm setting.• Changes in airway resistance and or compliance.• Decreased Breath Rate.
Setting range	<ul style="list-style-type: none">• 1.0 l/min to 30 l/min• Off
Setting resolution	0.1 l up to 1.0 l, 0.5 l above 1.0 l.
Ventilator action	The ventilator will continue treatment with the same settings.

6.3.9 High V_{t_e} Alarm (High Expired Tidal Volume)

Property	Description
Alarm text	High V_{t_e}
Priority	Medium
Alarm condition	A High Expired Tidal Volume alarm will be given when the monitored Expired Tidal Volume exceeds the alarm limit for 15 seconds.
Possible cause	<ul style="list-style-type: none">• Mismatch between Expired Tidal Volume and alarm setting.• Pressure settings causing the Expired Tidal Volume to exceed the set alarm level.
Setting range	<ul style="list-style-type: none">• 150 ml to 2500 ml (Adult mode)• 30 ml to 600 ml (Paediatric mode)• Off
Setting resolution	10 below 600 ml, 100 above 600 ml
Ventilator action	The ventilator will continue treatment with the same settings.

6.3.10 Low V_{t_e} Alarm (Low Expired Tidal Volume)

Property	Description
Alarm text	Low V_{t_e}
Priority	High
Alarm Condition	A Low Expired Tidal Volume alarm will be given when the monitored Expired Tidal Volume fails to reach the set limit for the Low Expired Tidal Volume alarm for 15 seconds.
Possible cause	<ul style="list-style-type: none">• Mismatch between Expired Tidal Volume and Alarm setting.• Changes in airway resistance and or compliance.• Leakage around the mask or within one of the components of the circuit.
Reset criteria	Full breath above set alarm limit
Setting range	<ul style="list-style-type: none">• 100 ml to 2000 ml (Adult mode)• 20 ml to 300 ml (Paediatric mode)• Off
Setting resolution	10 below 600 ml, 100 above 600 ml
Ventilator action	The ventilator will continue treatment with the same settings.

6.3.11 High MV_e (High Expired Minute Volume Alarm)

Item	Description
Alarm text	High MVe
Priority	Medium
Alarm condition	A High Expired Minute Volume alarm will be given when the monitored expired minute volume exceeds the alarm limit for 15 seconds.
Possible cause	<ul style="list-style-type: none">• Mismatch between Breath Rate, Tidal Volume settings and the alarm setting.• Increased Breath Rate.
Setting range	<ul style="list-style-type: none">• Adult mode: 1.0 to 40 l/min• Paediatric mode: 1.0 to 20 l/min• Off
Setting resolution	0.5 l/min
Ventilator action	The ventilator will continue treatment with the same settings.

6.3.12 Low MV_e Alarm (Low Expired Minute Volume)

Property	Description
Alarm text	Low MVe
Priority	High
Alarm condition	A Low Expired Minute Volume alarm will be given when the monitored minute volume is below the alarm limit for more than 15 seconds.
Possible cause	<ul style="list-style-type: none">• Mismatch between Breath Rate and Tidal Volume settings and the alarm setting.• Changes in airway resistance and or compliance.• Decreased Breath Rate.• Leakage around the mask or within one of the components of the circuit.
Setting range	<ul style="list-style-type: none">• 1.0 l/min to 30 l/min (Adult mode)• 0.1 l/min to 20 l/min (Paediatric mode)• Off
Setting resolution	0.1 l up to 1.0 l, 0.5 l above 1.0 l.
Ventilator action	The ventilator will continue treatment with the same settings.

6.3.13 High Breath Rate Alarm

Property	Description
Alarm text	High Breath Rate
Priority	Medium
Alarm condition	A High Breath Rate alarm will be given when the alarm limit has been exceeded for 15 seconds.
Possible cause	<ul style="list-style-type: none">• Mismatch between the Breath Rate setting and the alarm setting.• Increased Breath Rate.• Too sensitive setting of the inspiratory trigger setting.
Reset criteria	The breath rate goes below the alarm limit.
Ventilator action	The Vivo 45 will continue treatment according to the current settings.
Setting range	<ul style="list-style-type: none">• 10 bpm to 70 bpm (Adult mode)• 10 bpm to 99 bpm (Paediatric mode)• Off
Setting resolution	1 bpm.

6.3.14 Low Breath Rate Alarm

Property	Description
Alarm text	Low Breath Rate
Priority	High
Alarm condition	A Low Breath Rate alarm will be given when the delivered total breath rate is below the alarm limit for 15 seconds.
Possible cause	<ul style="list-style-type: none">• Mismatch between the Breath Rate setting and the alarm setting.• The patient cannot trigger breaths because the inspiratory trigger setting is too high.• Decrease in the patient's spontaneous breathing.• Circuit disconnection.
Reset criteria	The breath rate goes above the alarm limit.
Ventilator action	The Vivo 45 will continue treatment according to the current settings.
Setting range	<ul style="list-style-type: none">• 4 bpm to 30 bpm (Adult mode, non-MPV modes)• 1 bpm to 30 bpm (Adult mode MPV modes)• 6 bpm to 50 bpm (Paediatric mode)• Off
Setting resolution	1 bpm.

6.3.15 Apnea Alarm

Property	Description
Alarm text	Apnea
Priority	High
Alarm condition	An Apnea alarm will be given when no patient-triggered breath is detected for the set period of time. The Apnea alarm is only available if the Inspiratory trigger is activated.
Possible cause	<ul style="list-style-type: none">• Patient stopped breathing.• Patient decreases spontaneous breathing.• Circuit disconnection.• Inspiratory Trigger is set too high.
Reset criteria	Inspiratory effort detected by the Vivo 45.
Ventilator action	The Vivo 45 will continue treatment according to the current settings.
Setting range	<ul style="list-style-type: none">• 5 to 60 s. (Non MPV mode)• 15 to 900 s. (MPV mode)• Off
Setting resolution	5 s below 15 s. 15 s above 15 s. MPV mode: 15 s below 60 s. 60 s above 60 s.

6.3.16 Disconnection Alarm

CAUTION!



No single alarm can reliably detect all disconnections due to the number of possible combinations of therapy settings, circuit configurations and patient interfaces. To verify that patient disconnection can be detected, including if the patient interface becomes accidentally detached from the patient, it is advised to test the functionality of the Disconnection Alarm upfront with the complete set-up as used during treatment, including items such as filters, circuit, connectors, interface (mask, cannula etc.)

Property	Description
Alarm text	Disconnection
Priority	High
Alarm condition	A Disconnection alarm will be given when the measured flow exceeds the expected leakage flow at the set Pressure for 15 seconds.
Possible cause	<ul style="list-style-type: none"> • Too high leakage in the patient circuit. • The patient has removed the mask. • Circuit disconnection. • Pilot pressure tube disconnection
Reset criteria	The leakage is back within limits.
Ventilator action	The Vivo 45 will continue treatment according to the current settings
Setting range	<ul style="list-style-type: none"> • On • Off

6.3.17 Rebreathing Alarm

Property	Description
Alarm text	Rebreathing
Priority	High
Alarm condition	<p>Leakage Circuit A Rebreathing alarm will be given if the intentional leakage is too low for more than 15 seconds.</p> <p>MPV circuit A Rebreathing alarm will be given if air returns into the ventilator for more than 10 consecutive breaths.</p>
Possible cause	<ul style="list-style-type: none"> • Obstructed or occluded patient circuit. • Incorrect patient circuit. • Obstructed or removed CO₂ port from leakage circuit.
Reset criteria	The leakage is back within limits.
Ventilator action	The Vivo 45 will continue treatment according to the current settings.
Setting range	<ul style="list-style-type: none"> • On • Off

6.3.18 Obstruction Alarm

Property	Description
Alarm text	Obstruction
Priority	High
Alarm condition	An Obstruction alarm will be given if the inspiratory breathing tube becomes blocked and remains blocked for 2 consecutive breaths.
Ventilator action	With each breath cycle, upon detection of an obstruction the ventilator will reduce the airway pressure to the set PEEP. Treatment will resume with the start of the next breath cycle.
Reset Criteria	When the monitored compliance and resistance become normal after a breath.
Setting Range	<ul style="list-style-type: none">• High• Low• Off

6.3.19 High FiO₂ Alarm

Property	Description
Alarm text	High FiO₂
Priority	Medium
Alarm condition	A High FiO ₂ alarm will be given when the measured FiO ₂ exceeds the alarm limit for 30 seconds.
Possible cause	<ul style="list-style-type: none">• Increased oxygen inflow.• Decreased minute ventilation.
Reset criteria	FiO ₂ goes below the alarm limit
Setting range	<ul style="list-style-type: none">• 21% to 100%• Off
Setting resolution	1%
Ventilator action	The ventilator will continue treatment with the same settings.

6.3.20 Low FiO₂ Alarm

Property	Description
Alarm text	Low FiO₂
Priority	High
Alarm condition	A Low FiO ₂ alarm will be given when the measured FiO ₂ is below the alarm limit for 30 seconds.
Possible cause	<ul style="list-style-type: none">• Decreased oxygen inlet.• Disconnection of oxygen inlet.• Increased minute ventilation.• High leakage.
Setting range	<ul style="list-style-type: none">• 21% to 100%• Off
Setting resolution	1%
Ventilator action	The ventilator will continue treatment with the same settings.

6.3.21 High SpO₂ Alarm

Property	Description
Alarm text	High SpO₂
Priority	Medium
Alarm condition	A High SpO ₂ alarm will be given when the measured SpO ₂ exceeds the alarm limit for 30 seconds.
Possible cause	Too high flow of bleed-in oxygen.
Reset criteria	The SpO ₂ value goes back below the alarm limit.
Ventilator action	The Vivo 45 will continue treatment according to the current settings.
Setting range	<ul style="list-style-type: none">• 90 % to 100 %• Off
Setting resolution	1 %

This alarm requires a connected SpO₂ sensor.

6.3.22 Low SpO₂ Alarm

Property	Description
Alarm text	Low SpO₂
Priority	High
Definition	A Low SpO ₂ alarm will be given when the measured SpO ₂ is below the alarm limit for 30 seconds.
Possible cause	<ul style="list-style-type: none">• Too low flow of bleed-in oxygen.• Oxygen inlet is disconnected.• Delivered tidal volumes are too small.
Setting range	85% to 100%
Setting resolution	1%
Ventilator action	The ventilator will continue treatment with the same settings.

This alarm requires a connected SpO₂ sensor.

6.3.23 High EtCO₂ Alarm

Property	Description
Alarm text	High EtCO₂
Priority	High
Alarm condition	A High EtCO ₂ alarm will be given when the measured EtCO ₂ exceeds the alarm limit for 30 seconds.
Possible cause	<ul style="list-style-type: none">• Alarm limit is set too low.• Breath Rate too low.• Delivered Tidal Volume too low.• Excessive dead space between patient and leakage port.• Leak port occluded.
Setting range	1 to 99 mmHg Off
Setting resolution	1 mmHg
Ventilator action	The ventilator will continue treatment with the same settings.

This alarm requires a connected EtCO₂ sensor

6.3.24 Low EtCO₂ Alarm

Property	Description
Alarm text	Low EtCO₂
Priority	Medium
Alarm condition	A Low EtCO ₂ alarm will be given when the measured EtCO ₂ is below the alarm limit for 30 seconds.
Possible cause	<ul style="list-style-type: none">• Alarm limit is set too high.• Ventilator disconnection.• Excessive leakage in the Patient circuit/Interface.• Partial obstruction of the airways.• Breath Rate too high.• Delivered Tidal Volume too high.• Self triggering of the ventilator.
Setting range	1 to 99 mmHg Off
Setting resolution	1 mmHg
Ventilator action	The ventilator will continue treatment with the same settings.

This alarm requires a connected EtCO₂ sensor

6.3.25 High InspCO₂ Alarm (High Inspired CO₂)

Property	Description
Alarm text	High InspCO₂
Priority	High
Alarm condition	A High Inspired CO ₂ alarm will be given when the measured inspired CO ₂ exceeds the alarm limit for 30 seconds.
Possible cause	<ul style="list-style-type: none">• Alarm limit is set too low.• Excessive dead space between patient and leakage port.• Leakage port occluded.
Setting range	1 to 99 mmHg Off
Setting resolution	1 mmHg
Ventilator action	The ventilator will continue treatment with the same settings.

This alarm requires a connected EtCO₂ sensor

6.3.26 High Pulse Rate Alarm

Property	Description
Alarm text	High Pulse Rate
Priority	Medium
Alarm condition	A High Pulse Rate alarm will be given when the measured pulse rate exceeds the alarm limit for 15 seconds.
Possible cause	<ul style="list-style-type: none">• Insufficient ventilatory support.• Too low flow of bleed-in oxygen.• The PEEP value is set too high.• Bad positioning of the finger probe.
Reset criteria	The pulse rate goes back below the alarm limit.
Ventilator action	The Vivo 45 will continue treatment according to the current settings.
Setting range	30 to 230 bpm (beats per minute) Off
Setting resolution	5 bpm (beats per minute)

This alarm requires a connected SpO₂ sensor.

6.3.27 Low Pulse Rate Alarm

Property	Description
Alarm text	Low Pulse Rate
Priority	High
Alarm condition	A low pulse rate alarm will be given when the measured pulse rate goes below the alarm limit for 15 seconds.
Possible cause	<ul style="list-style-type: none">• Bad positioning of the finger probe.• Too low flow of bleed-in oxygen.• Insufficient ventilatory support.
Reset criteria	The pulse rate goes back above the alarm limit.
Ventilator action	The Vivo 45 will continue treatment according to the current settings.
Setting range	30 to 230 bpm (beats per minute) Off
Setting resolution	5 bpm (beats per minute)

This alarm requires a connected SpO₂ sensor.

6.3.28 PtcCO₂ Alarm

Property	Description
Alarm text	PtcCO₂ Outside Limits
Priority	High
Alarm Condition	A PtcCO ₂ alarm will be given when PtcCO ₂ is outside alarm limits. Check the PtcCO ₂ monitor.
Possible cause	<ul style="list-style-type: none">• External PtcCO₂ monitor is outside its alarm limits.• Breath Rate needs adjustment• Delivered Tidal Volume needs adjustment.• Excessive dead space between patient and leakage port.• Leak port occluded.• Ventilator disconnection.• Excessive leakage in the Patient circuit/Interface.• Partial obstruction of the airways.• Self triggering of the ventilator.
Ventilator action	The ventilator will continue treatment with the same settings.

This alarm requires a connected PtcCO₂ sensor.

6.4 Technical Alarms

6.4.1 Power Fail Alarm

Property	Description
Alarm text	The alarm is given audibly with a tone and the display is blinking with the alarm message Power Fail
Priority	High
Alarm condition	The Power Fail alarm is given if the last power source fails to provide enough power for running the ventilator.
Possible cause	The last available power source cannot deliver power to the ventilator. Battery discharged or battery failure.
Reset criteria	External power supply connected to ventilator.
Ventilator action	The Vivo 45 stops the treatment, and gives the Power Fail alarm for at least 2 minutes. If power is restored within the alarm time, the ventilator will automatically resume treatment with current settings. When powered up again, the power failure will be logged.

6.4.2 High Patient Air Temp. (High Patient Air Temperature)

Property	Description
Alarm text	High Patient Air Temp
Priority	High
Alarm condition	A High Patient Air Temperature alarm will be given when the patient air temperature exceeds 43°C (109.4°F).
Possible cause	<ul style="list-style-type: none">• Blocked air inlets.• Blocked cooling air outlets.• Too high ambient temperature.
Ventilator action	The Vivo 45 will continue treatment. If a heated circuit or the click-in humidifier is used, these will be turned off.
Reset criteria	The temperature goes below the limit again.

6.4.3 Low Patient Air Temp. (Low Patient Air Temperature Alarm)

Property	Description
Alarm text	Low Patient Air Temp
Alarm condition	A Low Patient Air Temperature alarm will be given when the patient air temperature is below the preset limit -30°C (-22°F).
Priority	High
Possible cause	Too low ambient temperature
Ventilator action	The ventilator will continue treatment with the same settings.

6.4.4 Low Last Power Source Alarm

Property	Description
Alarm text	Low Last Power Source
Priority	Medium
Alarm condition	This alarm will be given when the last battery source (internal battery) has 15 minutes of operating time left with current settings.
Ventilator action	The Vivo 45 will continue treatment according to the current settings.

6.4.5 Crit. Low Last Power Source Alarm

Property	Description
Alarm text	Crit. Low Last Power Source
Alarm condition	A Crit. Low Last Power Source alarm will be given when the last battery source (internal battery or click-in battery) has 5 minutes of operating time left with current settings.
Priority	High
Ventilator action	The ventilator will continue treatment with the same settings.
Reset	Connection of “higher” power source.

6.4.6 Lost Mains Alarm

Property	Description
Alarm text	Lost Mains Power
Alarm condition	A Mains Power Lost alarm will be given when the ventilator switched from AC power (Mains) to another power source due to AC Power (Mains) is lost.
Priority	Medium
Ventilator action	The ventilator will continue treatment with the same settings. An information message will be shown on the screen.
Reset	Confirmation by user or AC power (Mains) reconnected.

6.4.7 SpO₂ Disconnected (SpO₂ Sensor Failure/Disconnection Alarm)

Property	Description
Alarm text	SPO2 Disconnected
Alarm condition	An SpO ₂ Sensor Failure/Disconnection alarm will be given when an error signal or no signal from the SpO ₂ sensor has been detected for 2 seconds. Check the SpO ₂ sensor.
Priority	High
Possible cause	The SpO ₂ electronics cable has been disconnected and subsequently no communication (possibly due to disconnection) for 2 seconds. Failure in the SpO ₂ sensor.
Ventilator action	The ventilator will continue treatment with the same settings.
Reset	Confirmation by user or reconnected/changed.

6.4.8 SpO₂ Signal Lost Alarm

Property	Description
Alarm text	SPO2 Signal Lost
Alarm condition	SpO ₂ signal lost.
Priority	High
Possible cause	Signal lost reported by SpO ₂ electronics (due to patient removing the probe from finger, or sensor detached from SpO ₂ electronics).
Ventilator action	The ventilator will continue treatment with the same settings.
Reset	User presses OK or electronics cable is disconnected by the user, or the sensor is reconnected to the finger.

6.4.9 Poor SpO₂ Signal

Property	Description
Alarm text	Poor SPO2 Signal
Alarm condition	A Poor SpO ₂ signal alarm will be given when the SpO ₂ signal is not correct. Check the SpO ₂ sensor.
Priority	High
Possible cause	Artifact or low perfusion reported by SpO ₂ electronics
Ventilator action	The ventilator will continue treatment with the same settings.
Reset	OK message from SpO ₂ electronics or SpO ₂ electronics disconnected by user or SpO ₂ Signal Lost alarm is triggered.

6.4.10 CO₂ Disconnected (CO₂ Sensor Failure/Disconnection Alarm)

Property	Description
Alarm text	CO2 Sensor Disconnected
Alarm condition	A CO ₂ Sensor Failure/Disconnection alarm will be given when communication between the ventilator and the CO ₂ sensor has been lost for 2 seconds. Check the CO ₂ sensor.
Priority	High
Possible cause	<ul style="list-style-type: none">• CO₂ Sensor disconnected.• Failure in the CO₂ sensor.
Ventilator action	The ventilator will continue treatment with the same settings.
Reset	Confirmation by user or reconnected/changed.

6.4.11 CO₂ Accuracy Error Alarm

Property	Description
Alarm text	CO2 Accuracy Error
Alarm condition	A CO ₂ Accuracy Error alarm will be given when an accuracy error in the CO ₂ measurement has occurred.
Priority	High
Ventilator action	The ventilator will continue treatment with the same settings.
Reset	OK message from sensor or sensor disconnected by user.

6.4.12 Check CO₂ Adapter Alarm

Property	Description
Alarm text	Check CO2 Adapter
Alarm condition	A Check CO ₂ Adapter alarm will be given when the airway adapter is not attached correctly to the CO ₂ sensor. Check/replace the airway adapter.
Priority	High
Ventilator action	The ventilator will continue treatment with the same settings.
Reset	OK message from sensor or sensor disconnected by user.

6.4.13 CO₂ Sensor Error Alarm

Property	Description
Alarm text	CO2 Sensor Error
Alarm condition	A CO ₂ Sensor Error alarm will be given when an error in the CO ₂ sensor has occurred. Replace the CO ₂ sensor. CO ₂ monitoring cannot be performed in this condition.
Priority	High
Ventilator action	The ventilator will continue treatment with the same settings.
Reset	OK message from sensor or sensor disconnected by user.

6.4.14 FiO₂ Disconnected (FiO₂ Sensor Failure/Disconnection Alarm)

Property	Description
Alarm text	FiO₂ Disconnected
Alarm condition	An FiO ₂ Sensor Failure/Disconnection alarm will be given when no signal from the FiO ₂ sensor has been detected for 2 seconds. Check the FiO ₂ sensor.
Priority	High
Possible cause	<ul style="list-style-type: none">• FiO₂ Sensor disconnected.• Communication with the FiO₂ sensor failed.
Ventilator action	The ventilator will continue treatment with the same settings.
Reset	Confirmation by user or reconnected/changed.

6.4.15 Ambient Pressure Compensation Lost Alarm

Property	Description
Alarm text	Pressure Comp Lost
Priority	Medium
Alarm condition	An Ambient Pressure Compensation Lost alarm will be given when the automatic ambient pressure compensation functionality is out of order.
Ventilator action	The Vivo 45 will continue treatment according to the current settings. Normal atmospheric pressure at sea level will be used as approximation for the temporary ambient pressure compensation. If used at other altitude, delivered and measured pressures may deviate.
Reset	Reset of ventilator.

6.4.16 Temperature Comp. Lost (Ambient Temperature Compensation Lost Alarm)

Property	Description
Alarm text	Temperature Comp. Lost
Alarm condition	An Ambient Temperature Compensation Lost alarm will be given when the automatic ambient temperature compensation is out of order. There is no communication with the air temperature sensor or the value is out of range (less than -30°C (-22°F) or more than 70°C (158°F).
Priority	Medium
Ventilator action	The ventilator will continue treatment with the same settings. The accuracy of the volume measurement may be impaired.
Reset	Ambient temperature inside valid range.

6.4.17 Humidity Comp. Lost (Humidity Compensation Lost Alarm)

Property	Description
Alarm text	Humidity Comp. Lost
Alarm condition	An Humidity Compensation Lost alarm will be given when the automatic humidity compensation is out of order. 50% relative humidity is used for temporary compensation. If the ventilator is used at other humidities, delivered and measured pressure and flow may deviate.
Priority	Medium
Ventilator action	The ventilator will continue treatment with the same settings. The accuracy of the volume measurement may be impaired.
Reset	Air humidity sensor values (RH and temperature) inside valid range.

6.4.18 LED Failure Alarm

Property	Description
Alarm text	LED Failure
Alarm condition	A LED Failure alarm will be given when one or more LED indicators on the front panel are broken.
Priority	Medium
Ventilator action	The ventilator will continue treatment with the same settings.
Reset	Power-on reset of ventilator (or repair).

6.4.19 Low Alarm Battery Alarm

Property	Description
Alarm text	Low Alarm Battery
Alarm condition	An alarm for <i>Low Alarm Battery</i> will be given if the alarm battery is not charged enough to have power for a <i>Power Fail</i> alarm for at least 2 minutes.
Priority	Medium
Ventilator action	The ventilator will continue treatment with the same settings and start charging the alarm batteries.
Reset	When alarm energy storage level is sufficient to give an alarm for at least 2 minutes.

6.4.20 Alarm Battery Error Alarm

Property	Description
Alarm text	Alarm Battery Error
Alarm condition	Unable to communicate with super capacitor and read super capacitor status.
Priority	Medium
Ventilator action	The ventilator will continue treatment with the same settings.
Reset	When triggering condition is removed.

6.4.21 Internal/Click-In Battery Hot Alarm

Property	Description
Alarm text	Internal Battery — Internal Battery Hot Click-In Battery — Click-In Battery Hot
Alarm condition	An alarm for Internal/Click-In Battery Overheat in Discharge will be given when the internal or click-in battery reaches 55°C (131°F).
Priority	High
Ventilator action	The ventilator will continue treatment with the same settings. Battery discharging will be disabled (by the battery electronics) once the temperature gets to 60°C (140°F). (If the battery is last power source, the ventilator will stop running).



NOTE

The battery electronics by manufacture stops discharge at 60°C (140°F).

6.4.22 Heated Circuit Temp. Alarm

Property	Description
Alarm text	Heated Circuit Temp.
Alarm condition	A Heated Circuit temp alarm will be given when the measured temperature of the heated wire is outside the tolerance.
Priority	Medium
Ventilator action	The ventilator will continue treatment with the same settings.
Priority	Medium
Reset	Heated wire measured temp tolerance is inside limits.

6.4.23 High Humidifier Temp. Alarm

Property	Description
Alarm text	High Humidifier Temp.
Alarm condition	A Humidifier High Temperature alarm will be given if the humidifier heater plate temperature exceeds 76°C (169°F) for more than 2 seconds.
Priority	Medium
Ventilator action	The ventilator will turn off the click-in humidifier and then continue treatment with the same settings. A message with option to turn on the humidifier again will be displayed.
Reset	The alarm is dismissed when the humidifier temperature drops below 76°C (169°F), set humidifier temperature).

6.4.24 Humidifier Fault Alarm

Property	Description
Alarm text	Humidifier Fault
Alarm condition	<ul style="list-style-type: none">• All humidifier enabling conditions have been satisfied for 10 minutes, and• No humidifier setting changes have been made for 10 minutes, and• Heater plate temperature < 50°C (122 °F)• Humidifier set temperature > Ambient temperature ,and• The heater plate temperature is more than 5°C (41 °F) below the set temperature, or the heater plate temperature < -20°C (68 °F) or greater than 400°C (752 °F)
Priority	Medium
Ventilator action	The ventilator will turn off the humidifier and continue treatment with the same settings. The humidifier must be restarted manually when the cause of the alarm is resolved.

6.4.25 Heated Circuit Fault Alarm

Property	Description
Alarm text	Heated Circuit Fault
Alarm condition	A Heated Circuit Fault alarm will be given if a fault in the heated circuit electronics or temperature sensor is detected.
Priority	Medium
Ventilator action	The ventilator will turn off the heated circuit and continue treatment with the same settings. The heated circuit must be restarted manually when the cause of the alarm is resolved.
Reset	The alarm is dismissed when the heated circuit setting is changed to OFF, or the treatment is stopped. The power to the heated circuit is re-enabled when all enabling conditions are satisfied.

6.4.26 Internal Function Failure

Property	Description
Alarm text	Int. Function Failure
Priority	High
Alarm condition	Failure of internal function that prevents treatment or normal operation of the ventilator. The error code that follows the alarm text indicates the kind of function failure. All Internal Function Failure alarm error codes are defined and explained in the ventilator Service Manual.
Reset criteria	Restart the ventilator.
Ventilator action	The ventilator will stop the treatment and shut down.
Action to take	Restart the Vivo 45. If the alarm persists or reoccurs: Take a note of the error code and contact your supplier of the Vivo 45 .

6.4.27 Air Temp. Sensor Fail Alarm

Property	Description
Alarm text	Air Temp Sensor Fail
Alarm condition	The alarm is given in case of swivel boot temperature sensor communication failure or sensor reporting temperatures out of range (below -30°C (-22°F) or above 60°C (140°F).
Priority	Medium
Ventilator action	The ventilator will continue treatment with the same settings.

6.4.28 Internal Error Alarm

Property	Description
Alarm text	Internal Error
Priority	High
Alarm Condition	An internal Error alarm will be given when the ventilator has an internal error, followed by an error code for the specific failure. All Internal Error alarm error codes are defined and explained in the ventilator Service Manual.
Ventilator action	The ventilator will continue treatment with the same settings.
Reset action	Power off and restart the ventilator.

6.4.29 Database Integrity Fail Alarm

Property	Description
Alarm text	Database Integrity Failed
Priority	High
Alarm Condition	This alarm is given when the database integrity check fails.
Ventilator action	The ventilator will continue treatment with the same settings.
Reset action	Rebuild the database and restart the ventilator.

6.4.30 Cooling Fan Error Alarm

Property	Description
Alarm text	Cooling Fan Error
Alarm Condition	The Cooling Fan Error alarm shall be given when the cooling fan runs too slow.
Priority	High
Ventilator action	The ventilator will continue treatment with the same settings.
Reset	When cooling fan speed is above 275 rpm.

6.4.31 Clock Failure Alarm

Property	Description
Alarm text	Clock Failure
Priority	High
Alarm condition	The alarm shall be given when the real time clock value is invalid.
Ventilator action	The ventilator will continue treatment with the same settings.
Reset action	Restart the ventilator.

6.4.32 Internal Temp High Alarm

Property	Description
Alarm text	Internal Temp High
Priority	High
Alarm condition	The Internal High Temp alarm shall be given when the ventilator internal temperature is high. The internal temp high alarm is triggered when PTU/Sensor board temperature is higher than 65°C (149°F), or main board temperature is higher than 65°C (149°F), or motor temperature is higher than 85°C (185°F).
Ventilator action	The ventilator will continue treatment with the same settings.
Reset	When the triggering conditions are resolved.

6.4.33 Humidifier/Bypass Loose Alarm

Property	Description
Alarm text	Humidifier/Bypass Loose
Priority	Medium
Alarm condition	The Humidifier/Bypass Loose alarm shall be given when the air bypass/humidifier latch is stuck in the down position for 5 secs.
Ventilator action	The ventilator will continue treatment with the same settings.
Reset action	Reinsert the air bypass unit/humidifier and make sure the latch closes.

6.5 Alarm Test

6.5.1 Alarm Signal Test

When starting treatment, an automatic alarm signal test is performed. Check that the test is performed successfully, this is indicated by:

- A short beep indicating functional audio signaling.
- The alarm LED first lights yellow, then red, indicating functional visual signaling.
- The audio pause LED lights yellow.
- In about a second, both LEDs are turned off.

If the test fails, do not use the Vivo 45. Contact your supplier of the Vivo 45 for a technical check.

6.5.2 Mandatory Alarm Tests

This alarm test should be performed every 24th month or if the ventilator's function needs to be checked for any other reason.

The alarm test should be included in the regular inspections during maintenance.

To perform the alarm test, follow the instructions below:

Alarm Test Preparation

- 1 Connect the ventilator patient circuit to a test lung.
- 2 Connect the ventilator to Mains power supply.
- 3 Start the ventilator.
- 4 Adjust the settings as follows:

Setting	Value
Ventilation Mode	Pressure Support Ventilation (PSV)
Patient Mode	Adult
Insp. Pressure	15 cmH ₂ O
PEEP	5 cmH ₂ O
Rise Time	9
Insp. Trigger	9
Exp. Trigger	3
Min Insp. Time	Off
Max Insp. Time	Off
Backup Rate	12 bpm
Backup Insp. Time	2.0 s
Target Volume	Off

- 5 All alarm settings shall be set to Off if possible.
- 6 Start the treatment.

6.5.2.1 High and Low Pressure Alarm Tests

- 1 Set the high pressure alarm to 10 cmH₂O.
⇒ The high pressure alarm shall be given.
- 2 Set the high pressure alarm to 55 cmH₂O.
- 3 Set the low pressure alarm to 20 cmH₂O.
⇒ The low pressure alarm shall be given.
- 4 Set the low pressure alarm to 1.0 cmH₂O.

6.5.2.2 Expiratory Tidal Volume Alarm (V_{t_e}) Tests

- 1 Set up the ventilator as described in *Alarm Test Preparation*, page 117.
- 2 Set the high V_{t_e} alarm to 150 ml.
⇒ The high V_{t_e} alarm shall be given.
- 3 Set the high V_{t_e} alarm to Off.
- 4 Set the low V_{t_e} alarm to 400 ml.
The low V_{t_e} alarm shall be given.

6.5.2.3 EtCO₂ Related Alarm Test

This alarm test applies if the EtCO₂ accessory is used.

- 1 Connect the EtCO₂ sensor with an attached airway adapter to the Vivo 45.
- 2 Disconnect the airway adapter from the CO₂ sensor.
⇒ The check CO₂ adapter alarm shall be given.
- 3 Connect the airway adapter to the CO₂ sensor again.

6.5.2.4 SpO₂ Related Alarm Tests

These tests apply if the SpO₂ accessory is used,

- 1 Connect SpO₂ sensor to device and to your finger.
- 2 Set the low SpO₂ alarm to 85%.
- 3 Set the high SpO₂ alarm to be 90%.
- 4 Start treatment and wait 30 s.
⇒ High SpO₂ alarm should be given.
- 5 Stop treatment.
- 6 Set the high SpO₂ alarm to off.
- 7 Set the low SpO₂ alarm to be 100%.
- 8 Start treatment and wait 30 s.
⇒ Low SpO₂ alarm should be given.
- 9 Stop Treatment.
- 10 Set the low SpO₂ alarm to 85%.
- 11 Set the low pulse rate alarm to off.
- 12 Set the high pulse rate alarm to 30 bpm.
- 13 Start treatment and wait 30 s.
⇒ High pulse rate alarm should be given.
- 14 Stop treatment.
- 15 Set the high pulse rate alarm to off.
- 16 Set the low pulse rate alarm to be 230 bpm.
- 17 Start treatment and wait 30 s.
⇒ Low pulse rate alarm should be given.
- 18 Stop Treatment.
- 19 Set the low pulse rate alarm to off.

6.5.3 Optional Alarm Tests

In this chapter, methods for additional alarm tests are described. These tests are optional and not needed to ensure safe use of the ventilator.

6.5.3.1 High PEEP Alarm

- 1 Connect the ventilator patient circuit to a test lung and a CPAP device.
- 2 Set the CPAP device treatment pressure to 10 cmH₂O.
- 3 Adjust the ventilator settings as follows:

Setting	Value
Ventilation Mode	
Insp. Pressure	15 cmH ₂ O
PEEP	5 cmH ₂ O
Breath Rate	12 bpm
Insp. Time	1.5 s
Rise Time	5
Insp. Trigger	Off
Target Volume	Off

- 4 Start treatment on both the ventilator and the CPAP device.
- 5 Wait approximately 15 seconds before the High PEEP alarm shall be given.
- 6 Stop treatment. Test completed.

6.5.3.2 Low Pressure and Disconnection Alarms

- 1 Start treatment and disconnect the patient circuit.
- 2 Wait 15 seconds.
- 3 The Low Pressure Alarm and/or the Disconnection Alarm will be given.
- 4 Stop treatment. Test completed.

6.5.3.3 Obstruction Alarm

- 1 Start treatment; block the patient circuit completely to simulate an obstruction.
- 2 Wait approximately 10 seconds.
- 3 The Obstruction Alarm will be given.
- 4 Stop treatment. Test completed.

7 Cleaning and Maintenance



WARNING!

The Vivo 45 should be subjected to maintenance, service and control and any applicable upgrades, in accordance with Breas service instructions.



The Vivo 45 shall only be repaired or modified in accordance with Breas service manuals, technical bulletins, and any special service instructions, by service technicians that have been authorised after Breas Vivo 45 service training.



Do not under any circumstances attempt to service or repair the ventilator yourself. If you do so, the manufacturer will no longer be responsible for the performance and safety of the ventilator.

Deviation from these service instructions may lead to risk of personal injury!

The patient-connected parts and the filter must be cleaned and replaced regularly to ensure correct function of the ventilator. All replaced parts must be disposed of in accordance with local environmental regulations regarding the disposal of used equipment and waste.

7.1 Cleaning the Vivo 45



WARNING!

To avoid electrical shock, disconnect the power supply to the ventilator before cleaning. Do not immerse the ventilator into any fluids.



CAUTION!

Always be careful when cleaning to ensure that you do not damage any equipment.



Fluid must not be allowed to enter the ventilator.



Never apply any liquids directly on the ventilator by spraying, splashing or pouring. Use a moistened lint-free cloth when cleaning.



Do not use an excessive amount of liquid when cleaning the ventilator.



Do not autoclave the ventilator.

7.1.1 Main Unit

- 1 Switch off the Vivo 45 and disconnect the power supply.
- 2 Remove the patient circuit.
- 3 Disconnect all electric cables.
- 4 Clean the outside of the Vivo 45 using a lint-free cloth with a mild soap solution, and/or ethanol 70% for surface disinfection.
- 5 If the click-in humidifier is used, clean it as described in 5.7.12.6 *Cleaning the Water Chamber*, page 83.
- 6 Reconnect the patient circuit. Make sure all parts are dry before the ventilator is put into operation.

7.1.2 Air Pathway Disinfection

The table below lists the parts that might get contaminated by exhaled gases or bodily fluids during normal use or single fault condition.

Condition	Parts
With bacteria filter	<ul style="list-style-type: none">• Patient circuit• EtCO₂ airway adapter (if used)• Bacteria filter
Without bacteria filter	<ul style="list-style-type: none">• Patient circuit• EtCO₂ airway adapter (if used)• FiO₂ sensor (if used)• Patient air outlet/Pneumatic unit• Air bypass unit/water chamber• Blower/Inlet silencer• Air inlet with filters

In case of contamination, the internal air pathways of the Vivo 45 may be disinfected up to 5 times by a maximum 60 minute long validated ozone gas process.

Low resistance bacteria filter, if used, should be replaced every 24 hours.

7.1.3 Patient Circuit



The patient circuit should be cleaned and replaced in accordance with the manufacturer's instructions and care provider's instructions, where applicable. For safety information, read 2.4 *Usage of Patient Circuit*, page 16.

Always clean the patient circuit or use a new patient circuit when the ventilator is used by a new patient.

Check the patient circuit regularly for damage. In case of damage, replace the circuit



CAUTION!

Appropriate personnel should determine the duration of use for the patient circuit based on accepted infection control procedures.

7.2 Cleaning and Replacing the Filters

Patient air filters

NOTE

- Coarse filter (grey): This is a washable filter, wash the filter at least once a week and replace once a year. See 7.2.1 *Washing a coarse filter*, page 123 for washing instructions.
- Fine filter (white): This is a disposable filter that not shall be washed or reused. Replace the fine filter at least every month, or more frequently when used in environments rich of pollen, pet hair or other particles that might clog the filter.

The patient air filters are located in the filter cassette at the side of the ventilator.

- 1 Turn off the ventilator and place it on a dust free surface.
- 2 First Place the filters in the air inlet compartment, with the coarse filter outside the fine filter.

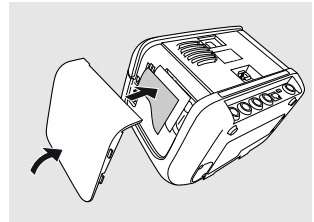

- 3 Close the side panel carefully for not displacing the filters while closing. For detailed information about closing the side panel, see 3.3.1 *Detaching and Reattaching the Side Panels*, page 26.

Cooling Air Filter

NOTE

The filter shall be washed at least once a week and replaced every second year. See 7.2.1 *Washing a coarse filter*, page 123 for washing instructions.

The cooling air inlet filter is located at the bottom left side of the ventilator.

- 1 Open the cooling air filter compartment by pulling at the top of the lid.

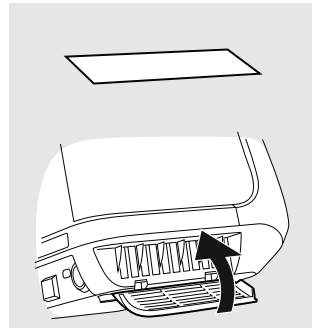

- 2 Remove the filter and wash or replace it.
- 3 Put back the filter and close the lid.

7.2.1 Washing a coarse filter

- 1 Wash the filter using warm water and a mild soap.
- 2 Rinse thoroughly.
- 3 Dry the filter by squeezing it out in a towel. Do not wring the filter.
- 4 Make sure the filter is completely dry before inserting.

7.3 Change of Patients

If the ventilator is used in a clinic by several patients, a low resistance bacterial filter may be used between the air outlet and the patient tube to prevent patient cross-contamination.

- 1 Follow the instructions in 7.1.1 *Main Unit*, page 120, steps 1 to 5.
- 2 Replace the patient filters according to 7.2 *Cleaning and Replacing the Filters*, page 122.
- 3 If a low resistance bacterial filter is used, it shall be replaced. To avoid cross-contamination when no bacterial filter has been used, a validated ozone-disinfection process may be used, see the section on disinfecting the main unit internally.
- 4 Use a new patient circuit when the ventilator is used by a new patient.

7.4 Regular Maintenance

Regular maintenance inspections and checks shall be carried out at least every 24 months, according to the ventilator Service Manual.

7.5 Service and Repair

The service and repair of the ventilator must only be carried out by authorised service personnel in accordance with Breas service instructions. Service inspections must always be carried out following any repairs to the device.



Authorised service workshops can order the ventilator Service Manual that contains all technical documentation required for the maintenance and service of the ventilator.

7.6 Storage

Store the ventilator in a dark room, where the temperature range is within -20 to +60°C (-4 to +140°F).

CAUTION!

The ventilator must not be stored in a warm place, such as direct sunlight or close to a radiator. The time required for the device to cool from the maximum storage temperature of +60°C (+140°F) until it is ready for use in ambient temperature of +20°C (+68°F) is 30 minutes.

If stored in a cold environment, let the ventilator adapt to room temperature before using the device. The time required for the device to warm from the minimum storage temperature of -20°C (-4°F) until it is ready for use in ambient temperature of +20°C (+68°F) is 30 minutes.



7.7 Disposal

The ventilator, any accessories and all replaced parts must be disposed of and recycled in accordance with the local environmental regulations regarding the disposal of used

equipment and waste. Contact your service provider for information regarding the disposal procedure.

NOTE

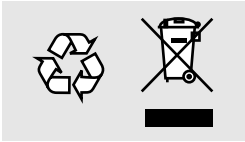

Batteries used with the ventilator shall be recycled in accordance with the local environmental regulations.



8 Technical Specifications

8.1 System Description

Leakage Port Configuration

This diagram provides an overview of the ventilator system when used with a leakage port patient circuit.

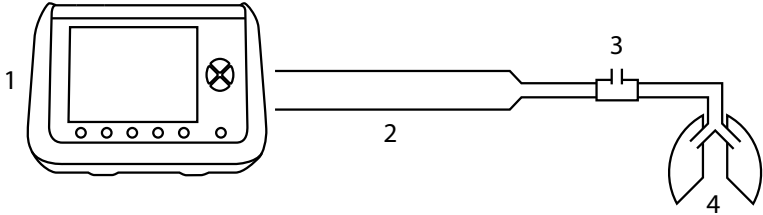

1. Vivo 45
2. Tube
3. Leakage port / Patient interface connection
4. Patient

8.1.1 Pneumatic Diagram for the ventilator

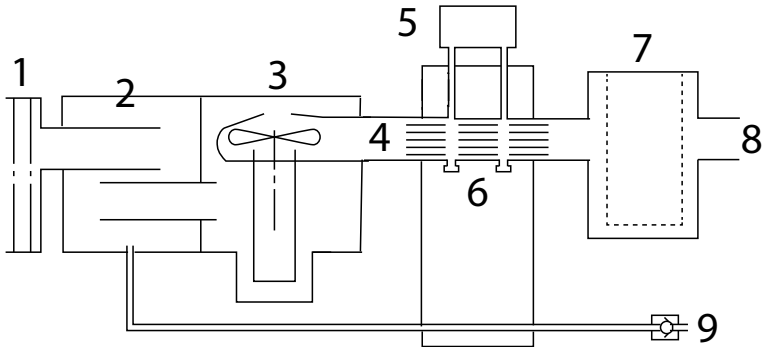

Item	Description
1	Air inlet with filters
2	Inlet silencer
3	Blower
4	Restriction
5	Flow sensor
6	Pressure sensors
7	Air bypass unit/Humidifier

Item	Description
8	Patient air outlet
9	Low pressure/bleed-in oxygen connection

8.2 Data

8.2.1 Worst Case Accuracy

Pressure Control Modes

The worst case Vivo 45 configuration is the 15 mm patient circuit with HCH humidifier, bacterial filter and EtCO₂ sensor.

8.2.2 Modes Specifications

This section lists the settings that can be made for the ventilator's modes.

Ventilation modes

- PSV (Pressure Support Ventilation). May be combined with:
 - TgV (Target Volume)
 - AE (Auto-EPAP)
- PCV (Pressure Controlled Ventilation). May be combined with:
 - A (Assist function — inspiration trigger)
 - TgV (Target Volume)
 - AE (Auto-EPAP)
 - MPV (Mouthpiece Ventilation)
- CPAP (Continuous Positive Airway Pressure)

Device modes

- Clinical
- Home

Patient modes

- Adult
- Paediatric

8.2.3 Parameter Specifications

This section lists the characteristics for the ventilator's parameters.

All stated tolerances includes measurement uncertainty. The accuracies have been tested with all allowed configurations. Stated tolerances only disclose the maximum tolerance. If a parameter's tolerance is described with both absolute and relative measures, the greater one applies.

Setting	Unit	Min	Max	Default	Resolution	Tolerance
Insp. Pressure	cmH ₂ O	4	40	15	0.5 < 10 1.0 ≥ 10	±0.5 cmH ₂ O or ±5%
CPAP	cmH ₂ O	4	20	10 (A) 8 (P)	0.5 < 10 1.0 ≥ 10	±0.5 cmH ₂ O or ±5%
PEEP	cmH ₂ O	2	20(3)	5 (A) 2 (P)	0.5 < 10 1.0 ≥ 10	±0.5 cmH ₂ O or ±5%
Breath Rate	bpm(4)	4 (A) 6 (P)	40 (A) 60 (P)	12 (A) 20 (P)	1	±2%
Backup Rate	bpm(4)	4 (A) 6 (P) 0 (MPV)	40 (A) 60 (P) 40 (MPV)	12 (A) 20 (P) 0 (MPV)	1	±2%
Backup Insp. Time	s	0.3	5 (A) 2 (P)	1.5 (A) 1 (P)	0.1	± (20 ms + 5% of setting) or ±0.1 s,
Inspiratory Time	s	0.3	5 (A) 2 (P)	1.5 (A) 1 (P)	0.1	± (20 ms + 5% of setting) or ±0.1 s,
Min Insp. Time	s	0.3 Off	3 (A) 2 (P)	Off	0.1	± (20 ms + 5% of setting) or ±0.1 s,
Max Insp. Time	s	0.3	5 (A) 2 (P) Off	Off	0.1	± (20 ms + 5% of setting) or ±0.1 s,
Inspiratory Trigger	Step	1	9 Off (5)	3 (A) 2 (P)	1	-
Expiratory Trigger	Step	1	9(5)	3	1	-
Rise Time	Step	1	9	3	1	-

(A)= Adult mode, (P)= Paediatric mode, (1)= 0.5 cmH₂O < 10 cmH₂O, 1.0 cmH₂O ≥ 10 cmH₂O, (3)= Also limited by Insp. Pressure- 2 cmH₂O, (4)= breath per minute, (5)= Off is only available in Control/ Assist mode, (6)Values >10 might initially be set with a 0.5 step when turning on Auto-EPAP. When changing the value, whole numbers will be used.

Setting	Unit	Min	Max	Default	Resolution	Tolerance
Max Pressure	cmH ₂ O	Current <i>Min Pressure</i>	40	15	0.5 < 10 1.0 ≥ 10	±0.5 cmH ₂ O or ±5%
Min Pressure	cmH ₂ O	4	Current <i>Max Pressure</i>	15	0.5 < 10 1.0 ≥ 10	±0.5 cmH ₂ O or ±5%
Target Volume	ml	Off 300 (A) 100 (P)	2000 (A) 500 (P)	Off	10 < 500 50 ≥ 500	±12 ml or ±10%,
Auto-EPAP	-	Off	On	Off	-	-
EPAP Min	cmH ₂ O	2	20 or Current <i>EPAP Max</i>	5	0.5 < 10 1.0 ≥ 10	±0.5 cmH ₂ O or ±5%
EPAP Max	cmH ₂ O	2 or Current <i>EPAP Min</i>	20 or <i>Pressure Limit-2</i>	5	0.5 < 10 1.0 ≥ 10	±0.5 cmH ₂ O or ±5%
EPAP Step	cmH ₂ O	0.5	2	1	0.5	±0.5 cmH ₂ O or ±5%
PS	cmH ₂ O	2	40 - Current <i>EPAP Max</i>	10	0.5 < 10 1.0 ≥ 10 (6)	±0.5 cmH ₂ O or ±5%
Min PS	cmH ₂ O	2	40 - Current <i>EPAP Max</i>	Variable(1)	0.5 < 10 1.0 ≥ 10 (6)	±0.5 cmH ₂ O or ±5%
Max PS	cmH ₂ O	2	40 - Current <i>EPAP Max</i>	10	0.5 < 10 1.0 ≥ 10 (6)	±0.5 cmH ₂ O or ±5%
Pressure Limit	cmH ₂ O	Current <i>EPAP Max</i> +2	40	<i>High Pressure Alarm - 2</i>	0.5 < 10 1.0 ≥ 10	±0.5 cmH ₂ O or ±5%
Relax Time	Minute	2	12 Off	5	1	± (20 ms + 5% of setting) or ±0.1 s,

(A)= Adult mode, (P)= Paediatric mode, (1)= 0.5 cmH₂O < 10 cmH₂O, 1.0 cmH₂O ≥ 10 cmH₂O, (3)= Also limited by Insp. Pressure- 2 cmH₂O, (4)= breath per minute, (5)= Off is only available in Control/Assist mode, (6) Values >10 might initially be set with a 0.5 step when turning on Auto-EPAP. When changing the value, whole numbers will be used.

Setting	Unit	Min	Max	Default	Resolution	Tolerance
Ramp	Minute	10 Off	60	Off	10	\pm (20 ms + 5% of setting) or \pm 0.1 s,
Always Start Ramp	-	Off	On	Off	-	-
Ramp Start Pressure	cmH ₂ O	2	Current <i>Insp.</i> Pressure - 2 or Current <i>CPAP</i>	5	0.5 < 10 1.0 \geq 10	\pm 0.5 cmH ₂ O or \pm 5%
Humidifier Setting	Step	1	5	3	1	-
Heated Circuit Temp	°C/°F	16/61	30/86	27/81	0.5	
Audible Alarm Level	Step	1	5	3	1	-

(A)= Adult mode, (P)= Paediatric mode, (1)= 0.5 cmH₂O < 10 cmH₂O, 1.0 cmH₂O \geq 10 cmH₂O, (3)= Also limited by *Insp.* Pressure- 2 cmH₂O, (4)= breath per minute, (5)= *Off* is only available in Control/ Assist mode, (6)Values >10 might initially be set with a 0.5 step when turning on Auto-EPAP. When changing the value, whole numbers will be used.

8.2.4 Monitored Values Specifications

This section describes the ranges and tolerances for monitored values on the Vivo 45.

All stated tolerances include measurement uncertainty. The accuracies have been tested with all allowed configurations. Stated tolerances only disclose the maximum tolerance.

P_{peak}

Range/Performance: 4 to 99 cmH₂O.

Tolerance: ± 0.5 cmH₂O or $\pm 10\%$, whichever is greatest

PEEP

Range/Performance: 0 to 99 cmH₂O.

Tolerance: ± 0.5 cmH₂O or $\pm 10\%$, whichever is greatest

P_{mean}

Range/Performance: 0 to 99 cmH₂O.

Tolerance: ± 0.5 cmH₂O or $\pm 10\%$, whichever is greatest

CPAP_{pressure}

Range/Performance: 0 to 99 cmH₂O.

Tolerance: $\pm (4\% \text{ CPAP set pressure} + 0.8 \text{ cmH}_2\text{O})$

Leakage

Range/Performance: 0 to 99.9 l/min (BTPS*).

Tolerance: $\pm 10\%$

MV_i

Range/Performance: 0 to 99.9 l (BTPS*).

Tolerance: $\pm 10\%$ or $(\pm 10 \text{ ml} \times \text{bpm})$, whichever is greatest

MV_e

Range/Performance: 0 to 99.9 l (BTPS*).

Tolerance: $\pm 10\%$ or $(\pm 10 \text{ ml} \times \text{bpm})$, whichever is greatest

Vt_i

Range/Performance: 0 to 9999 ml (BTPS*).

Tolerance: $\pm 10 \text{ ml}$ or 10% , whichever is greatest

Vt_e

Range/Performance: 0 to 9999 ml (BTPS*).

Tolerance: $\pm 10 \text{ ml}$ or 10% , whichever is greatest

FiO₂

Range/Performance: 0 to 100%.

Tolerance: $\pm 2\%$

% in TgV

Range/Performance: 0 to 100%.

Tolerance: $\pm 1\%$

Total Rate

Range/Performance: 0 to 99 bpm.

Tolerance: ± 1 bpm

Spont Rate

Range/Performance: 0 to 99 bpm.

Tolerance: ± 1 bpm

% Spont

Range/Performance: 0 to 100%.

SpO₂

Range/Performance: 70 to 100%.

Tolerance: ± 3 digits. No motion and flex sensor.

Pulse Rate

Range/Performance: 25 to 240 bpm.

Tolerance: ± 3 digits. No motion and flex sensor.

I:E

Range/Performance: 1:10 to 10:1.

Tolerance: ± 0.1 unit for I:E < 9.9, ± 1 unit otherwise.

Insp. Time

Range/Performance: 0.3 to 5 s.

Tolerance: ± 0.1 s

Rise Time

Range/Performance: 0.1 to 5 s.

Tolerance: $\pm 10\%$ or ± 0.1 s, whichever is greatest

EtCO₂

Range/Performance: 0 to 25%.

Tolerance: 0 to 15%: $\pm (0.2 \text{ vol}\% + 2\% \text{ of reading})$. 15 to 25%: unspecified

InspCO₂

Range/Performance: 0 to 25%.

Tolerance: 0 to 15%: $\pm (0.3 \text{ vol}\% + 4\% \text{ of reading})$. 15 to 25%: unspecified

8.2.5 Power Supply

AC supply: 100 to 240 V AC, tolerance: $+10\%/-20\%$, 50 to 60 Hz, 1.0 - 2.0 A.

External DC: 19 V DC, tolerance: $19 \text{ V} \pm 6 \text{ V}$. Max 90 W.

Click-in battery: Capacity: 65Wh. Li-ion.

Internal battery: Capacity: 25Wh. Li-ion. Expected service life: 500 full charging cycles.

8.2.6 Environmental Conditions

Operating temperature range: 5 to 40°C (41 to 104°F)

Storage and transport temperature: -20 to +60°C (-4 to +140°F)

Ambient pressure range:

700 to 1100 mbar, corresponding to ~4200 metres (13800 feet) above sea level to ~700 metres (2300 feet) below sea level, at normal atmospheric pressure.

As seen in the graph above, the ventilator is unable to deliver set max pressure at a very low ambient pressure.

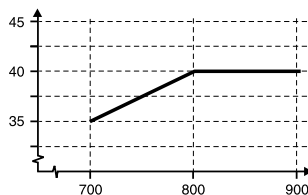
**Ingress Protection:**

IP22

Solid particle protection: Hazardous parts are protected from touch by fingers and by objects greater than 12 mm.

Liquid ingress protection: The protection withstands dripping water less than 15 degrees from vertical.

The ingress protection has been tested by water drips equivalent to 3mm rain/minute for 10 minutes (2.5 minutes for each tilting direction).

8.2.7**Other****Patient Circuit Leakage**

Recommended leakage: 20 to 50 l/min at 10 cmH₂O (leakage circuit)

Minimum leakage: 12 l/min at 4 cmH₂O (leakage circuit)

Oxygen Inlet

Oxygen inlet port: Maximum flow: 30 l/min (medical oxygen). Oxygen coupling is type CPC PMCD181032.

Start-up Time

Start-up from unpowered state: about 20 seconds.

Sound Power Level

Sound level at 10 cmH₂O in CPAP mode: Less than 30 dB(A). Measured at 1 m.

Alarm sound level: Adjustable 50–80 dB(A), Measured at 1m. Tolerance: ± 5 dB(A).

Miscellaneous

Maximum flow: > 300 l/min

Maximum flow at 20 mbar: > 150 l/min

Maximum limited pressure during single fault condition: 80 cmH₂O (PCV, PSV) 30 cmH₂O (CPAP)

Breathing resistance under single-fault: <6 cmH₂O at 30 l/min, <6 cmH₂O at 60 l/min

Vivo 45 Dimensions

W × H × D: 216 × 159 × 152 mm

Weight: 2.4 kg

Patient air outlet: 22 mm male, conical standard connector

EtCO₂ Sensor

W × H × D: 38 × 37 × 34 mm

Cable length: 2.4 m

Weight: 75 g

Warm-up time: 10 s

Total system response time: 30 s

Interference from medical gases: O₂: <-0.1% relative CO₂ per % O₂
(calibrated at 21% O₂)

FiO₂ Sensor

Total system response time : 20 s

Filtering/Smoothing Techniques

Pressure: Low pass average time constant 16 ms

Inspiration trigger: Differential mass flow resolution 4 ms

Expiration trigger: Flow low pass filtering with level sensing

SpO₂: No data post-processing done by the ventilator

Effort Belt: Low pass filter: 5Hz, High pass filter: 0.1Hz

8.3 Emission and Immunity Declaration

According to IEC 60601-1-2:2014.

The performance of all functions of the ventilator is considered as essential performance for the purpose of immunity testing.

8.3.1 Vivo 45 Essential Performance

The ventilator will deliver ventilation at the patient-connection port within its published accuracy specifications and within the alarm limits set by the operator, or generate an alarm condition for high pressure, low pressure, high PEEP, low tidal volume, low minute volume, low breath rate, high EtCO₂, high and low FiO₂, obstruction, low last power source, or power failure.

The ventilator will provide SpO₂ and pulse rate values within its published accuracy specifications and generate an alarm upon a low SpO₂ condition. The ventilator will provide indication when the SpO₂ value or pulse rate is potentially incorrect, and generate an alarm condition to indicate when the SpO₂ value update period has exceeded 30 seconds.

The ventilator will provide EtCO₂ and FiO₂ values within its published accuracy specifications and generate an alarm condition upon high and low EtCO₂ and FiO₂ conditions.

Under the immunity test conditions, the following allowances are acceptable:

- Error of delivered volume and PEEP of individual breaths up to 35% and error of the delivered volume and PEEP averaged over a one-minute interval up to 25%.
- Any temporary degradation of SpO₂, EtCO₂ or FiO₂ performance following transient immunity test exposure shall recover from any disruption within 30 seconds.

Additionally, the following shall not be allowed:

- permanent damage or unrecoverable loss of function,
- changes in programmable parameters or settings,
- reset to default settings,
- change of operating mode,
- initiation of unintended operation.

8.3.2 Guidance and Manufacturer's Declaration – Electromagnetic Immunity

The ventilator is intended for use in the electromagnetic environment specified below. The customer or the user of the ventilator should assure that it is used in such an environment.

Immunity Test	Compliance Level	Electromagnetic Environment - Guidance
Electrostatic discharge (ESD) IEC 61000-4-2	± 8 kV contact ± 15 kV air	The relative humidity should be at least 5 %.
Electrical fast transient/burst IEC 61000-4-4	± 2 kV for power supply lines ± 1 kV for input/output lines	AC Power (Mains) quality should be that of a typical commercial, hospital and residential environment.
Surge IEC 61000-4-5	± 1 kV line to line	AC Power (Mains) quality should be that of a typical commercial, hospital and residential environment.
Power frequency (50/60 Hz) magnetic field IEC 61000-4-8	30 A/m	Power frequency magnetic fields should be at levels characteristic of a typical location in a typical commercial, hospital and residential environment.
Voltage dips, short interruptions and voltage variations on power supply input lines IEC 61000-4-11	0% U_T , 0.5 cycle (multiple phase analysis); 0% U_T , 1 cycle; 70% U_T , 25/30 cycles (50/60 Hz); 0% U_T , 250/300 cycles (50/60 Hz);	Vivo 45 runs on internal battery during voltage dips, short interruptions and voltage variations on power supply input lines.



U_T is the AC Power (Mains) voltage prior to application of the test level.



WARNING!

Portable RF communications equipment (including peripherals such as antenna cables and external antennas) should be used no closer than 30 cm (12 inches) to any part of the ventilator, including cables specified. Otherwise, degradation of the performance of this equipment could result.

Immunity Test	Compliance Level	Electromagnetic Environment - Guidance
Conducted RF IEC 61000-4-6	3 V _{rms} (150 kHz to 80 MHz) 6 V _{rms} (inside ISM/ASR bands)	$d=0.35*\sqrt{P}$ m at 150 kHz to 80 MHz
Radiated RF IEC 61000-4-3	10 V/m 80 MHz to 2.5 GHz	$d= 1.2*\sqrt{P}$ m at 80 MHz to 800 MHz $d= 2.3*\sqrt{P}$ m at 800 MHz to 2.5 GHz Equation description: P is the maximum output power rating of the transmitter in watts (W) according to the transmitter manufacturer and, except for portable RF communications equipment, d is the recommended separation distance in meters (m). Field strengths from fixed RF transmitters, as determined by an electromagnetic site survey ^a , should be less than the compliance level in each frequency range ^b . Interference may occur in the vicinity of equipment marked with this symbol: 

NOTE

At 80 MHz and 800 MHz, the higher frequency range applies.

These guidelines may not apply in all situations. Electromagnetic propagation is affected by absorption and reflection from structures, objects and people.

a) Field strengths from fixed transmitters, such as base stations for radio (cellular/cordless) telephones and land mobile radios, amateur radio, AM and FM radio broadcast and TV broadcast cannot be predicted theoretically with accuracy. To assess the electromagnetic environment due to fixed RF transmitters, an electromagnetic site survey should be considered. If the measured field strength in the location in which the ventilator is used exceeds the applicable RF compliance level above, the ventilator should be observed to verify normal operation. If abnormal performance is observed, additional measures may be necessary, such as reorienting or relocating the ventilator.

b) Over the frequency range 150 kHz to 80 MHz, field strengths should be less than 10 V/m.



8.3.3 Guidance and Manufacturer's Declaration – Electromagnetic Emission

The ventilator is intended for use in the electromagnetic environment specified below. The customer or the user of the ventilator should assure that it is used in such an environment.

Emissions test	Compliance Level	Electromagnetic Environment - Guidance
RF emissions CISPR 11	Group 1	The ventilator uses RF energy only for its internal function. Therefore, its RF emissions are very low and are not likely to cause any interference in nearby electronic equipment.
RF emissions CISPR 11	Class B	The ventilator is suitable for use in all establishments, including domestic establishments and those directly connected to the public low-voltage power supply network that supplies buildings used for domestic purposes.
Harmonic emissions IEC 61000-3-2	Class A	
Voltage fluctuations/flicker emission IEC 61000-3-3	Complies	

8.3.4 Frequencies of portable and mobile transmitters for which the recommended separation distance is 30 cm (12 inches)

Band (MHz)	Service	Immunity test level (V/m)
380 — 390	TETRA 400	27
430 — 470	GMRS 460, FRS 460	28
704 — 787	LTE Band 13, 17	9
800 — 960	GSM 800/900, TETRA 800, iDEN 820, CDMA 850, LTE Band 5	28
1,700 — 1,990	GSM 1800; CDMA 1900; GSM 1900; DECT; LTE Band 1, 3, 4, 25; UMTS	28
2,400 — 2,570	Bluetooth, WLAN 802.11 b/g/n, RFID 2450, LTE Band 7	28
5,100 — 5,800	WLAN 802.11 a/n	9

8.3.5 Recommended separation distances between external power conductors and the ventilator

Rated maximum current in conductor (A)	Separation distance (m)
	50-60 Hz $d = I/2\pi H = I/188$
1	0.005
10	0.05
30	0.16

For conductors rated at a maximum current not listed above, the recommended separation distance d in metres (m) can be estimated using the equation $d = I/2\pi H$, where I is the maximum current rating of the conductor in amperes (A) according to the transmitter manufacturer; H is the ventilator immunity compliance level to electromagnetic fields in the 50-60 Hz frequency span (30 A/m).

8.4 Delivery Settings

Delivery settings: modes and functions

Ventilation Mode: Pressure

Breath Mode: Support

Patient Mode: Adult

Device Mode: Clinical

Home Adjust: Off

Profile 1: Active

Profile 2: Off

Profile 3: Off

Delivery Settings, Alarms

High Pressure Alarm:

25 cmH₂O (Adult)

20 cmH₂O (Paediatric)

Low Pressure Alarm: 10 cmH₂O

High PEEP Alarm: Off

Low PEEP Alarm: Off

High V_te Alarm: 500 ml (Adult), 400 ml (Paediatric)

Low V_te Alarm: 300 ml (Adult), 100 ml (Paediatric)

High MV_e Alarm: Off

Low MV_e Alarm: Off

High Breath Rate Alarm: Off

Low Breath Rate Alarm: Off

Apnea Alarm: Off

Disconnection Alarm: On

Rebreathing Alarm: On

Obstruction Alarm: Off

High FiO₂ Alarm: Off

Low FiO₂ Alarm: Off

High SpO₂ Alarm: Off

Low SpO₂ Alarm: Off

High EtCO₂ Alarm: 51 mmHg

Low EtCO₂ Alarm: Off

High InspCO₂ Alarm: Off

Low Pulse Rate: Off

High Pulse Rate: Off

Other

Patient operating time: 0 h

Display light: On

Light Intensity: 9

Alarm sound level: 5

CO₂ Unit: mmHg

Auto keypad lock: Off

Pre-use Test: On

9

Accessories and Parts



WARNING!

Only use accessories recommended by Breas Medical. Breas Medical cannot guarantee the performance and safety for the use of other accessories with the ventilator.



NOTE

Accessory equipment connected to the analogue and digital interfaces must be certified according to the respective IEC standards (e.g. IEC 60950 for data processing equipment and IEC 60601-1 for medical equipment). Furthermore all configurations must comply with the valid version of the system standard IEC 60601-1-1. Anybody who connects additional equipment to the signal input part or signal output part is configuring a medical system, and is therefore responsible for ensuring the system complies with the requirements of the valid version of the system standard IEC 60601-1-1. If in doubt, consult the technical service department or your local representative.

The following Breas accessories have been verified for use with the Vivo 45.:

9.1

Patient Circuits and Air Delivery Accessories

Circuit: 22 mm smoothbore with leak port

Function: Delivers air to the patient, applied part

Part No: 005060

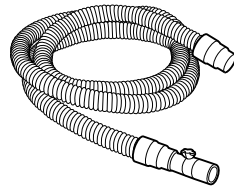

Circuit: 1.8m x 22mm Smoothbore disposable

Function: Delivers air to the patient, applied part

Part No: 009118

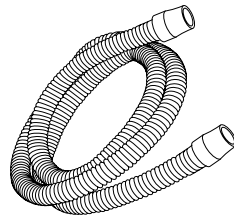

Circuit: Single limb 22 mm. Single patient multiple use.

Function: Delivers air to the patient, applied part

Part No: 008426 (30-pack of 004465)

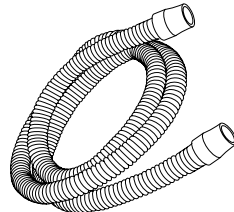

Circuit: Single limb heated wire 15 mm, disposable

Function: Deliver heated air to the patient, non-invasively

Part No: 006193

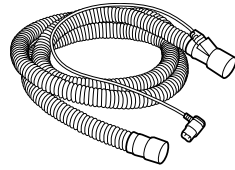

Circuit: Single limb 22 mm with leakage port and bacterial filter, disposable

Function: Delivers air to the patient (applied part)

Part No: 007615

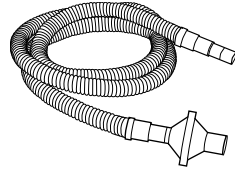

Circuit: 1.8m x 15mm Smoothbore Disposable

Function: Deliver air to the patient

Part No: 009119

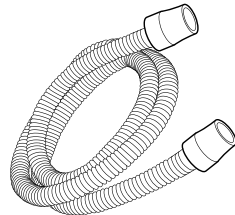

Circuit: Single limb 15 mm

Function: Deliver air to the patient

Part No: 008427 (30-pack of 006712)

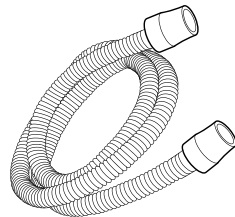

Circuit: Single limb 22 mm, with bacterial filter, disposable

Function: Deliver air to the patient

Part No: 007936

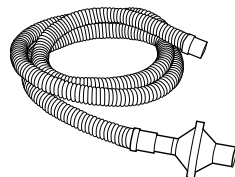

Leakage Port

Function: Providing a leakage for clearing exhaled gases.

Part No: 004426

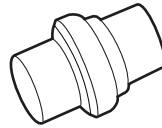

Low resistance bacterial filter, with CO₂ connector

Function: Filter air at ventilator outlet

Characteristics

- Resistance:
0.5 cmH₂O @ 30 l/m
1.4 cmH₂O @ 60 l/m
2.76 cmH₂O @ 90 l/m
- Deadspace: 33 ml
- BFE (Bacterial Filtration Efficiency): 99.9999%
- VFE (Viral Filtration Efficiency): 99.999 %

Part No: 007963

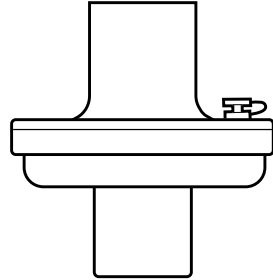

Low pressure oxygen adapter

Function: Oxygen tube adapter with connector for the Vivo 45.

Part No: 005032

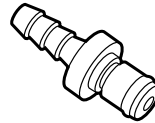

Circuit: Single limb for Mouthpiece ventilation (MPV)

Function: Deliver air to the patient

Part No: 006093

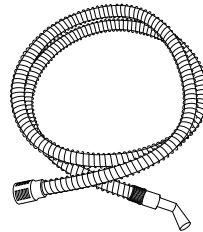

Mouthpiece

Function: Patient interface for Mouthpiece ventilation (MPV)

Part No: 006094



MPV arm

Function: Hold an MPV circuit so Mouthpiece can be mounted close to the patient

Part No: 006095

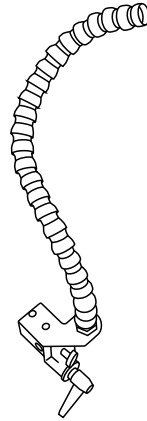

9.2 Power Accessories

Car Adapter Cable

Function: 12–24 VDC car adapter cable.

Part No: 007653

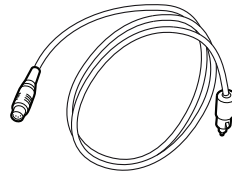

Power Supply

Function: Deliver power to the ventilator

Part No: 006396

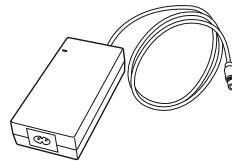

Power cord

Function: Deliver power to the AC power supply

Part No:

GB: 003521

CN: 005304

EU: 003520

JP: 004834

US: 003522



XPAC - External battery with charger

Function: Extends usage time of supported Breas products.

Part No Cable for connection to device: 007671

Part No Charger with cable:

Single: Charger with one battery

Dual: Charger with two batteries

Single: 007995, Dual: 007999

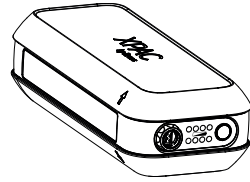

Click-in battery

Function: Power source for transportation

Part No: 006265

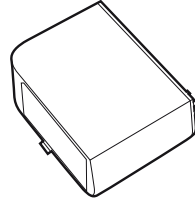

Click-in Battery Charger

Function: External charger for click-in batteries, available with bank for 2 or 4 batteries)

Part no:

07730 (2 batteries charger)

007731 (4 batteries charger)

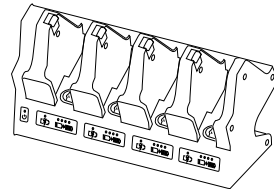

Cable, external DC

Function: External DC cable.

Part No:006709

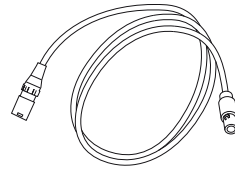

Cable, external DC to Ventilator Adapter

Function: Connect the ventilator to external DC

Part No: 006710

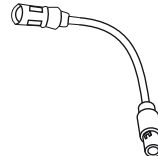

Cable, Y-adapter, Mains AC and External DC to Ventilator

Function: Connects the ventilator to both mains and external DC at the same time. If the Mains power source is available, it will have precedence over the DC power source.

Part No: 006711



9.3 Monitoring Accessories

Breas PC software

Function: Data monitoring software

Part No: 006718

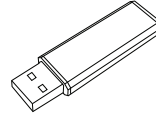

USB cable

Function: Data cable: PC to Vivo 45 (USB to USB)

Part No: 005757

Memory card

Function: Storage and transfer of settings, patient data and usage data

Part No: 006705

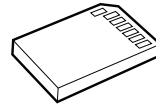

Memory card reader/writer

Function: Read/write memory card

Part No: 002185

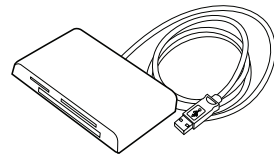

Remote alarm with cable

Function: Monitor Vivo 45 alarms remotely

Part No: 10 m: 006348, 25 m: 006349

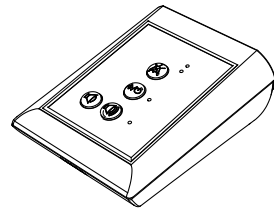

Remote alarm cable

Function:

Part No: 10 m: 006359, 25 m: 006360, 50 m: 006361

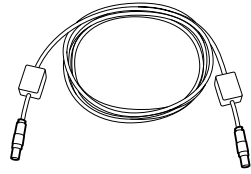

Nurse call cable

Function: Connect the ventilator to a hospital nurse call system

Part No:

NO: 006365

NC: 006364

10 k Ω , NO: 006363

10 k Ω , NC: 006362

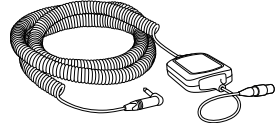

Remote start/stop

Function: Start and stop the ventilator remotely. Also, pause audio remotely.

Part No: 006649

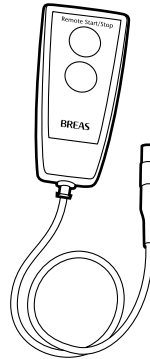

FiO₂ sensor

Function: Measure FiO₂ to the patient.

Part No: 006172



SpO₂ module

Function: Connection interface

Part No: 006369

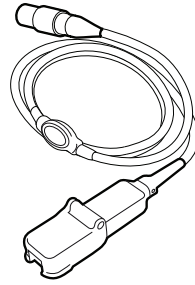

SpO₂ sensor

Function: Finger Clip SpO₂ sensor

Part No:

Adult: 006589

Paediatric: 006590

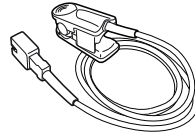

SpO₂ sensor

Function: Multisite SpO₂ sensor

Part No: 006591

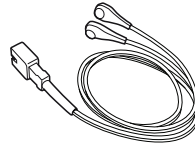

EtCO₂ sensor

Function: Measure CO₂ in the airflow

Part No: 006346

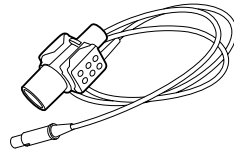

Airway adapter

Function: Connects the EtCO₂ sensor to the patient circuit

Part No: 005263 (25 pcs)

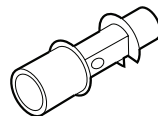

PtcCO₂ Cable, Sentec

Function: Connects the ventilator to a Sentec PtcCO₂ monitor.

Part No: 006179

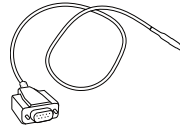

PtcCO₂ Cable, Radiometer

Function: Connects the ventilator to a Radiometer TCM5 PtcCO₂ monitor.

Part No: 008392

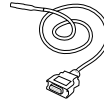

Effort belt communication box

Function: Connects the ventilator to one or two effort belts.

Part No: 006182



Effort belt wireset

Function: Connects an effort belt to the communication box

Part No: 007083

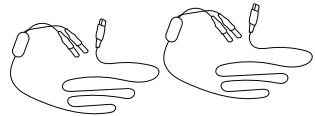

Effort belt

Function: Measures respiratory effort

Part No:

Adult:

24"-74" (107-188 cm): 007085

45"-123" (114-312 cm): 007091

Paediatric:

16"-42" (41-107 cm): 007084

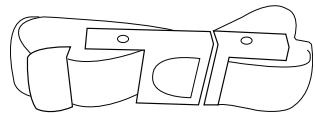

9.4 Ventilator Filters and Detachable Parts

Patient air inlet filter, fine, white, disposable

Function: Fine inlet air filtration.

Material: AS 100

NaCl Penetration: (0.65 μm NaCl @ 95 l/min) = <7.35%

Part No: 007103 (5pcs)



Patient air inlet filter, coarse, grey, washable

Function: Coarse inlet air filtration

Material: Bulpren S 28133

Filter diameter: 1080-1580 Microns

Part No: 007104 (5pcs)

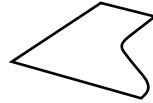

Cooling air filter

Function: Device air inlet filtration, 5 pieces

Part No: 007105

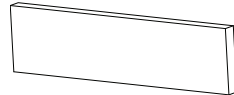

Air bypass unit

Function: Direct the air flow within the ventilator

Part No: 007064

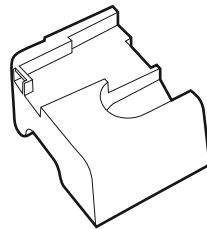

Click-in water chamber

Function: Humidify the patient air

Part No: 006490

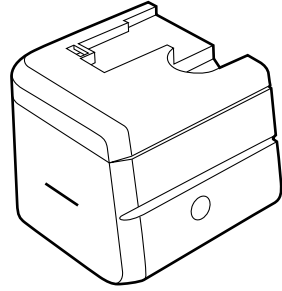

Side panels

Function: Protect the internal ventilator components.

Part No:

Grey: 007065, Blue: 007066, Light blue: 007518

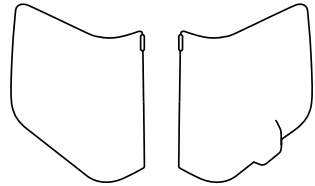

9.5 Other Accessories

Trolley

Function: Mobile use, transportation

Part No: 007384

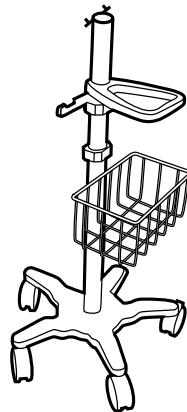

Patient circuit arm

Function: To support a patient circuit.

Part No: 007917

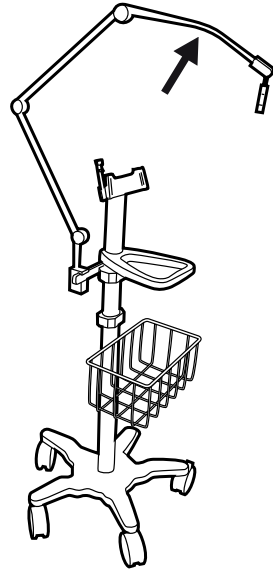

Universal rail clamp

Function: Attach a humidifier to a trolley. This accessory is part of the trolley system.

Part No: 007858

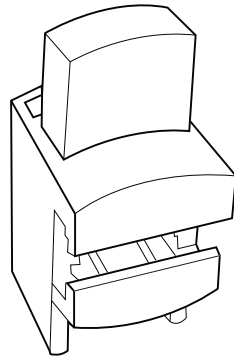

E-cylinder holder

Function: Attach an E-cylinder to a trolley. This accessory is part of the trolley system.

Part No: 005128

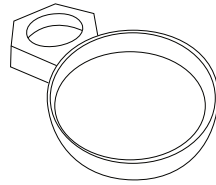
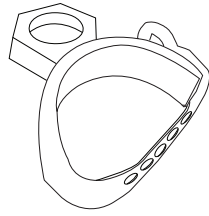

IV-pole

Function: Pole with hooks to hang IV fluid bags.

Part No: 007859

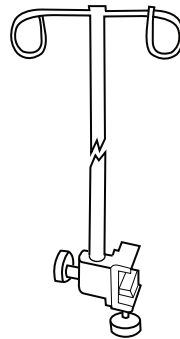

Mounting bracket

Function: Mount the ventilator to a stand / trolley / rail system.

Part No: 006761

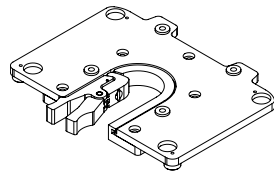

Protective cover

Function: Shock protection

Part No: 006067



Lightweight Mobility Bag

Function: Mobile use

Part No: 007555

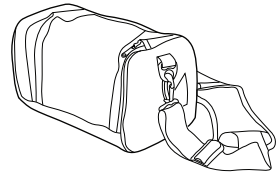

Carry bag

Function: Storage for transportation

Part No: 006014



10 Patient Settings

This section can be copied and used for noting the patient's settings.

Patient Settings - Vivo 45

Patient

Date

Clinic

Set by

Ventilation mode:.....

Patient Circuit	
Insp. Pressure	Inspiratory Trigger
PEEP	Expiratory Trigger
Breath Rate	Min Inspiratory Time
Inspiratory Time	Max Inspiratory Time
Backup Rate	Backup Inspiratory Time
Target Volume	Min Pressure
Max Pressure	CPAP
Auto-EPAP	EPAP step
EPAP Min	EPAP Max
PS	Pressure Limit)
PS Min	PS Max
Relax Time	

Notes

.....

11 FAA Compliance

To whom it may concern:

In line with the FAA Advisory Circular AC 91.21-1D October 27, 2017, this kind of respiratory assistive device may be used onboard an aircraft, without further testing by the carrier, provided they have been tested for Electromagnetic Compatibility (EMC) in accordance with the current version of RTCA/DO-160, Section 21, Category M.

Breas Medical has successfully completed testing for the ventilator System. The ventilator System complies with RTCA/DO-160, Section 21, Category M and can be considered FAA compliant.

Some airlines may require advance notification before travel, and devices may need to be operated by battery. Breas Medical recommends that customers check with their airline.

FAA Compliance (English text)

To whom it may concern:

In line with the FAA Advisory Circular AC 91.21-1D October 27, 2017, this kind of respiratory assistive device may be used onboard an aircraft, without further testing by the carrier, provided they have been tested for Electromagnetic Compatibility (EMC) in accordance with the current version of RTCA/DO-160, Section 21, Category M.

Breas Medical has successfully completed testing for the ventilator System. The ventilator System complies with RTCA/DO-160, Section 21, Category M and can be considered FAA compliant.

Some airlines may require advance notification before travel, and devices may need to be operated by battery. Breas Medical recommends that customers check with their airline.

Index

A

- AC power
 - connect 33
- Accessories
 - usage 69
- Adjust
 - patient settings 36
- Adult mode 54
- Air filters
 - clean and replace 122
- Air inlet, position 25
- Air pathway
 - disinfection 121
- Air Temp. Sensor Fail alarm 114
- Alarm
 - Air Temp. Sensor Fail 114
 - Alarm Battery Error 111
 - Ambient Pressure Compensation
 - Lost 109
 - Ambient Temperature Compensation Lost 110
 - Apnea 97
 - Check CO₂ Adapter 108
 - Clock failure 115
 - CO₂ Disconnected (CO₂ Sensor Failure/Disconnection Alarm) 107
 - CO₂ Sensor Error 108
 - CO₂ Sensor Error (CO₂ Accuracy Error Alarm) 108
 - Cooling Fan Error 115
 - Crit. Low Last Power Source 106
 - Database Integrity Fail 115
 - Disconnection 97
 - FiO₂ Disconnected (FiO₂ Sensor Failure/Disconnection Alarm) 109
 - Heated Circuit Fault 113
 - Heated Circuit Temp. 112
 - High breath rate 95
 - High EtCO₂ 101
 - High FiO₂ 99
 - High Humidifier Temp. 112
 - High InspCO₂ 102
 - High MVe 94
 - High Mvi 92
 - High Patient Air Temp (High Patient Air Temperature) 105
 - High PEEP 90
 - High pressure 88
 - High pulse rate 103
 - High SpO₂ 100
 - High Vte 93
 - High Vti 91
 - Humidifier Fault 113
 - Humidifier/bypass loose 116
 - Humidity Compensation Lost 110
 - Internal Error 114
 - Internal Function Failure 114
 - Internal temp high 116
 - Internal/Click-In Battery Hot 111
 - LED Failure 110
 - Lost AC Power (Mains) 106
 - Low Alarm Battery 111
 - Low Battery 105
 - Low breath rate 96
 - Low EtCO₂ 102
 - Low FiO₂ 100
 - Low MVe 94
 - Low MVi 92
 - Low Patient Air Temp. (Low Patient Air Temperature Alarm) 105
 - Low PEEP 90
 - Low pressure 89
 - Low pulse rate 103
 - Low SpO₂ 101
 - Low Vte 93
 - Low Vti 91
 - Obstruction 99
 - Poor SpO₂ Signal 107
 - Power Failure Alarm 104
 - PtcCO₂ Alarm 104
 - Rebreathing 98
 - SpO₂ Disconnected (SpO₂ Sensor Failure/Disconnection Alarm) 106
 - SpO₂ Signal Lost 107
- Alarm Battery Error alarm 111
- Alarms 85
 - technical 104
- Always start ramp (setting) 62
- Ambient Pressure Compensation Lost alarm 109
- Ambient Temperature Compensation Lost alarm 110
- Apnea alarm 97
- Artificial nose 18

Assisted Pressure Controlled Ventilation	
definition	56
Assisted Pressure Controlled Ventilation with Target Volume	
definition	56
Audible range	
operator's position	87
Audio pause and reset	87
B	
Backup insp. time	60
Bacterial filter	18
Battery	
charge	64
click-in	64
connect click-in battery	64
Breath mode	54
Breath rate	59
C	
Cables	
inspect	35
Calibration	
CO ₂	71
Caution	
Icon	10
Change patients	123
Charge batteries	67
Check	
before first use	31
Check CO ₂ Adapter alarm	108
Circuit	
connect	34
Cleaning	120
CO ₂ sensor	71
main unit	120
patient	121
Cleaning and maintenance	
safety information	19
Click-in battery	66
charger	67
connect	67
Click-in humidifier	
using	78
Clock failure alarm	115
CO ₂ Accuracy Error Alarm (CO ₂ Sensor Error) alarm	108
CO ₂ sensor	
clean	71
connect	71
safety information	71
specifications	130
usage	71
CO ₂ Sensor Error alarm	108
CO ₂ Sensor Failure/Disconnection Alarm (CO ₂ Disconnected) alarm	107
CO ₂ unit	49
CO ₂ zeroing	73
Compliance data	
read	49
Connect	
click-in battery	66
CO ₂ sensor	71
nurse call	69
to mains	33
Continuous Positive Airway Pressure	
definition	56
Contraindications	8
Cooling air filter	
replace	122
Cooling Fan alarm	115
CPAP	62
definition	56
Crit. Low Last Power Source alarm	106
Curves screen	49
D	
Date	
set	49
Date format	49
DC power	
click-in battery LED	24
external DC	24
external DC LED	24
internal battery LED	24
Delivery settings	137
Device information	49
Device mode	54
Device settings	49
Dimensions	130
Disconnection alarm	97
Disinfection	

air pathway	121	Heated circuit	
Display		settings	49
home mode overview	46	Heated circuit (on/off. setting)	63
light	49	Heated circuit (temp. setting)	63
navigate	41	Heated Circuit Fault alarm	113
overview	45	Heated Circuit Temp alarm	112
symbols	42	Heated patient circuit	
E		connect	34
Effort belts		using	83
using	75	High breath rate alarm	95
Electrical safety		High EtCO ₂ alarm	101
user precautions	14	High FiO ₂ alarm	99
Enter		High Humidifier Temp. alarm	112
standby mode	39	High InspCO ₂ alarm	102
Environmental conditions		High Mve alarm	94
safety information	15	High Mvi alarm	92
specifications	126	High Patient Air Temperature	
Equipment designation and		Alarm (High Patient Air	
safety label	28	Temp) alarm	105
Exp. Trigger	60	High PEEP alarm	90
External DC	68	High pressure alarm	88
F		High pulse rate alarm	103
Filter		High SpO ₂ alarm	100
bacterial	18	High Vte alarm	93
disposable	22	High Vti alarm	91
safety information	18	HME	18
Filtering/smoothing techniques		Home Adjust	53
specifications	126	Home mode	49, 53
Filters		activate	53
clean and replace	122	overview	44
FiO ₂ Sensor Failure/Disconnection Alarm (FiO ₂ Disconnected) alarm	109	Humidification	
First use check	31	safety information	18
Font panel		Humidifier	
main unit	24	detaching	82
Function		filling	79
navigation buttons	24	installing	80
G		Humidifier (on/off setting)	63
General user precautions	12	Humidifier (value setting)	63
H		Humidifier Fault alarm	113
HCH	18	Humidifier/bypass loose alarm	116
Heat and moisture exchanger	18	Humidity Compensation Lost	
		alarm	110
		Hygroscopic condenser humidifier	18
		Hypoventilation	96
		I	
		Icon	65
		Caution	10
		Note	10

Reference.....	10
Warning	10
Information button.....	24
Insp. Pressure.....	59
Insp. Time.....	59
Insp. trigger.....	60
Inspect	
before use.....	35
cables.....	35
placement.....	35
Intended use.....	8
Internal battery.....	65
Internal alarm.....	114
Internal Function Failure alarm.....	114
Internal temp high alarm.....	116
Internal/Click-In Battery Hot alarm.....	111
L	
Label.....	28
Language	
selecting for clinical mode.....	49
selecting for home mode.....	49
Leakage circuit (single limb) pneumatic diagram.....	125
LED	
click-in battery.....	24
external DC.....	24
front panel.....	24
internal battery.....	24
LED Failure alarm.....	110
Light intensity.....	49
Lost AC Power (Mains) alarm.....	106
Low Alarm Battery alarm.....	111
Low Battery alarm.....	105
Low breath rate alarm.....	96
Low EtCO ₂ alarm.....	102
Low FiO ₂ alarm.....	100
Low MVe alarm.....	94
Low MV _i alarm.....	92
Low Patient Air Temperature Alarm (Low Patient Air Temp) alarm.....	105
Low PEEP alarm.....	90
Low pressure alarm.....	89
Low pulse rate.....	103
Low SpO ₂ alarm.....	101
Low V _t e alarm.....	93
Low V _t i alarm.....	91

M

Main components.....	22
Main unit	
clean.....	120
Mains	
connect.....	33
Maintenance	
filters.....	122
service information.....	123
Maximum inspiratory time.....	61
Memory card slot	
position.....	25
Menu	
navigate.....	41
symbols.....	42
Minimum inspiratory time.....	61
Modes	
definitions.....	53
Monitor section.....	49
Monitored value	
% in TgV.....	52
% Spont.....	52
EtCO ₂	53
FiO ₂	52
I:E.....	53
Insp. time.....	53
InspCO ₂	53
Leakage.....	51
MV _e	52
MV _i	52
PEEP.....	51
P _{mean}	51
P _{peak}	51
P _{tc} CO ₂	53
Pulse Rate.....	53
Rise time.....	53
SpO ₂ (oxygen saturation).....	53
Spont Rate.....	52
Total Rate.....	52
V _t e.....	52
V _t i.....	52
Monitored values.....	50
Mouthpiece	
pressure mode.....	56
MPV	
pressure mode.....	56

N	
Navigate	
menu	41
Note	
Icon	10
Nurse call	
connect	69
electrical safety	14
O	
Obstruction alarm	99
On/Off	
switch	39
Operating conditions	
specifications	126
Operating mode	54
Operator's position	
audible range	87
Others section	49
Oxygen	
safety information	20
usage	20
Oxygen inlet	
position	28
specification	126
P	
Paediatric mode	54
Part numbers	
main components	22
Pathway	
internal disinfection	121
Patient air filters	
clean and replace	122
Patient air outlet	
position	25
Patient circuit	
connect	34
safety information	16
Patient mode	54
Patient operating time	49
Patient profiles	49
Patient settings	
adjust	36
Patients	
change	123
PCV	
definition	55
mouthpiece	56
PCV(A)	
definition	56
PCV(A+IgV)	
definition	56
PCV(IgV)	
definition	55
PEEP	59
Perform pre-use test	36
Placement	31
inspect	35
Pneumatic diagram	
leakage circuit (single limb)	125
single limb circuit	125
Poor SpO ₂ Signal alarm	107
Position	
operator, audible range	87
Power Failure Alarm alarm	104
Power source priority	63
Power supply specification	126
Pre-use test	49
Pre-Use Test	
Failure	37
Pressure controlled ventilation	
mouthpiece	56
Pressure Controlled Ventilation	
definition	55
Pressure Controlled Ventilation with Target Volume	
definition	55
Pressure Support Ventilation	
definition	55
Pressure Support Ventilation with Target Volume	
definition	55
Pressure unit	49
Priority	
power source	63
Product label	28
Profile	
select	47
Profiles	
delivery settings	137
Protective cover	77
PSV	
definition	55
PSV(IgV)	
definition	55
PtcCO ₂ Alarm	104

R

Ramp	
start	39
Ramp time	62
Rebreathing alarm	98
Reference	
Icon	10
Regular maintenance	123
Remote alarm	
using	71
Remote Start/Stop	76
Repair	123
Reset alarm	87
Rise time	60

S

Safety information	
cleaning and maintenance	19
CO ₂ sensor	71
environmental conditions	15
filters	15
humidification	18
oxygen	20
patient circuit	16
Safety label	28
Screen	
alarm	48
alarm/event history	48
curves	49
home mode main screen	
overview	46
Monitor	49
Others	49
Trends	49
Section	
Alarm	48
Monitor	49
Others	49
Setup	47
Serial number	49
Service	123
Settings	
at delivery	137
specification	126
Side panel	25
Single limb circuit	
pneumatic diagram	125
Sound level	

specification	126
Specifications	
CO ₂ sensor	126
dimension	126
environmental conditions	126
Filtering/smoothing	
techniques	126
miscellaneous	126
monitored values	126
operating conditions	126
oxygen inlet	126
power supply	126
settings	126
sound level	126
SpO ₂	
usage	75
SpO ₂ Sensor Failure/Disconnection Alarm (SpO ₂ Disconnected) alarm	106
Standby mode	
enter	54
Start	
switch on and enter standby	
mode	39
treatment	39
Start pressure (ramp)	62
Start-Stop	
using remote	76
Start-up time	
specification	126
Stop	
treatment	39
storage	
battery	67
Storage	123
Switch off	39
Switch on/off	39
Symbols	
equipment designation and safety	
label	28
menu	42

T

Target volume	61
in PCV + A, definition	56
in PCV, definition	55
in PSV, definition	55
Technical alarms	104
Time	

set.....	49
Time format	49
Treatment	
select preset profile	47
start.....	39
stop.....	39
Trends screen	49

U

Undesirable side effects.....	8
Up/Down buttons.....	24
User interface	
navigate.....	41
symbols.....	42
User precautions	
electrical safety	14
environmental conditions.....	15
general.....	12
patient circuit.....	16

V

Values	
monitored	50
Ventilation mode.....	54

W

Warning	
Icon.....	10
Water chamber	
detaching	82
filling	79
installing.....	80
open lid.....	83
Water trap.....	18
Weight.....	126
Wheelchair	
protective cover.....	77