



# Breas Vivo 3 User Manual

007469 F-3a en-US

Vivo 3, User's  
  
ENGLISH (US)

Vivo 3 User Manual



Breas Medical AB, Företagsvägen 1, SE-435 33 Mölnlycke, Sweden  
Phone +46 31 86 88 00  
Order +46 31 86 88 20, Technical Support +46 31 86 88 60  
Fax +46 31 86 88 10, www.breas.com, Date: 2025-01-28 | 28861



7 321820 074693



# Table of Contents

1	Introduction .....	5
1.1	Manufacturer Information .....	5
1.2	What is the Vivo 3? .....	6
1.2.1	Non Invasive Interfaces .....	6
1.2.2	Mobility and Usage Environment .....	6
1.2.3	Continuous Operation .....	6
1.2.4	Service Life .....	6
1.2.5	High Flow Nasal Therapy Mode .....	6
1.3	Intended Use .....	7
1.4	Indications for Use .....	7
1.5	Operation by Lay Users .....	7
1.6	Contraindications .....	7
1.7	About this Manual .....	8
1.7.1	Audience .....	8
1.7.2	Icons in this Manual .....	8
2	Safety Information .....	10
2.1	General Use — Warnings and Precautions .....	10
2.2	Electricity — Warnings and Precautions .....	12
2.2.1	Electromagnetic Compatibility and Electrostatic Discharge (EMC and ESD) .....	13
2.3	Environment — Warnings and Precautions .....	14
2.4	Patient Circuit — Warnings and Precautions .....	14
2.5	Filter Usage — Warnings and Precautions .....	16
2.6	Invasive Use — Warnings and Precautions .....	17
2.7	Humidification and Heating — Warnings and Precautions .....	17
2.8	Cleaning and Maintenance — Warning and Precautions .....	18
2.9	Oxygen Usage — Warning and Precautions .....	20
2.10	Mobile Use — Warning and Precautions .....	21
3	Product Description .....	22
3.1	Overview .....	22
3.2	Ventilator Front .....	22
3.3	Ventilator Back .....	23
3.4	Power Management .....	23
3.5	Menus .....	24
3.5.1	Use the Menu .....	24
3.5.2	The Monitor Page .....	27
3.5.3	The Setup Pages .....	28
3.5.4	The Alarm Pages .....	28
3.5.5	The Others Pages .....	28
3.6	Symbols on the Vivo 3 .....	31
3.7	Symbols on the Display .....	34

4	Treatment Functions and Settings .....	35
4.1	Treatment Settings .....	35
4.1.1	Ramp Up .....	35
4.1.2	Ramp Down .....	35
4.1.3	Humidifier .....	35
4.1.4	Humidifier Level .....	36
4.1.5	Heated Circuit .....	36
4.1.6	Heated Circuit Level .....	36
5	Prepare the Vivo 3 for Use .....	37
5.1	Checking the Vivo 3 before First Use .....	37
5.2	Placing the Vivo 3 .....	37
5.3	Connecting the Vivo 3 to Power Supply .....	37
5.4	Connecting the Patient Circuit .....	38
5.4.1	Connect the Heated Patient Circuit .....	38
5.4.2	Disconnect the Heated Patient Circuit from the Ventilator .....	39
5.5	Performing Start-up Checks .....	39
5.6	Performing a Pre-Use Test .....	39
5.6.1	Actions At Pre-Use Test Failure .....	40
6	How to Use the Vivo 3 .....	41
6.1	Switch On the Vivo 3 .....	41
6.2	Start the Treatment .....	41
6.3	Stop the Treatment .....	42
6.4	Switch Off the Vivo 3 .....	43
6.5	Monitor Treatment .....	43
6.5.1	Treatment Values Monitored by the Vivo 3 .....	44
6.6	Using Accessories .....	44
6.6.1	Using the Attachable Humidifier .....	44
6.6.2	Using the Heated Circuit .....	47
6.6.3	Using the SpO <sub>2</sub> Module .....	48
6.6.4	Oxygen Supply After the Patient Air Outlet .....	49
6.6.5	Using the Nurse Call Connection .....	50
6.6.6	Using the Remote Alarm Unit .....	50
6.6.7	Using the Protective Cover .....	51
6.6.8	Using the Lightweight Mobility Bag .....	51
6.6.9	Using the Y-Cable .....	51
6.6.10	Using the Vivo 3 with the Trolley .....	51
6.7	Basic Troubleshooting .....	53
7	Alarms .....	54
7.1	Operator's Position .....	54
7.1.1	Checking the Operator's Position .....	55
7.2	Handle Alarms .....	55

	7.2.1	Identify an Alarm Condition .....	55
	7.2.2	Pause the Alarm Sound .....	56
	7.2.3	Reset an Alarm .....	56
	7.2.4	View Historical Alarms .....	57
	7.2.5	Adjust the Alarm Sound Level .....	58
7.3		Physiological Alarms .....	58
	7.3.1	High Pressure Alarm .....	59
	7.3.2	Low Pressure Alarm .....	59
	7.3.3	High Breath Rate Alarm .....	60
	7.3.4	Low Breath Rate Alarm .....	60
	7.3.5	High Minute Volume Alarm .....	61
	7.3.6	Low Minute Volume Alarm .....	61
	7.3.7	Rebreathing Alarm .....	62
	7.3.8	Apnea Alarm .....	62
	7.3.9	Disconnection Alarm .....	62
	7.3.10	High EPAP Alarm .....	63
	7.3.11	Low EPAP Alarm .....	63
	7.3.12	High SpO <sub>2</sub> Alarm .....	64
	7.3.13	Low SpO <sub>2</sub> Alarm .....	64
	7.3.14	High Pulse Rate Alarm .....	64
	7.3.15	Low Pulse Rate Alarm .....	65
	7.3.16	Circuit Disconnection Alarm .....	65
	7.3.17	Blocked Circuit Alarm .....	65
7.4		Technical Alarms .....	66
	7.4.1	High Pressure Limitation Alarm .....	66
	7.4.2	Power Fail Alarm .....	66
	7.4.3	SpO <sub>2</sub> Sensor Failure / Disconnected Alarm .....	67
	7.4.4	SpO <sub>2</sub> Artifact .....	67
	7.4.5	Ambient Pressure Compensation Lost Alarm .....	68
	7.4.6	Low Battery Alarm .....	68
	7.4.7	Critically Low Battery Alarm .....	68
	7.4.8	High Patient Air Temp. (High Patient Air Temperature) .....	69
	7.4.9	Flow Sensor Failure .....	69
	7.4.10	Internal Function Failure .....	70
8		Cleaning and Maintenance .....	71
	8.1	Cleaning the Vivo 3 .....	71
		8.1.1 Clean the Main Unit Externally .....	71
		8.1.2 Clean the Humidifier Water Chamber .....	72
		8.1.3 Clean the Patient Circuit .....	72
		8.1.4 Intentionally Deleted .....	72
	8.2	Clean and Replace Patient Air Inlet Filters .....	72

8.3	Disposal .....	73
9	Technical Specifications .....	74
9.1	Ventilator Size and Weight .....	74
9.2	Power Supply .....	74
9.3	Operating Conditions .....	75
9.4	Emission and Immunity Declaration .....	76
9.4.1	Guidance and Manufacturer's Declaration – Electromagnetic Immunity .....	78
9.4.2	Guidance and Manufacturer's Declaration – Electromagnetic Emission .....	80
9.4.3	Recommended separation distances between portable and mobile RF communications equipment and the ventilator .....	80
9.4.4	Recommended separation distances between external power conductors and the ventilator .....	81
10	Accessories .....	82
10.1	Patient Circuits and Air Delivery Accessories .....	82
10.2	Power Accessories .....	83
10.3	Ventilator Filters and Detachable Parts .....	83
10.4	Monitoring Accessories .....	84
10.5	Other Accessories .....	86
	Appendix .....	89
	Index .....	91

# 1

## Introduction

### WARNING!

#### Risk of Personal Injury

The Vivo 3 must only be used:



- For the intended treatment in accordance with this manual and with the instructions given by the responsible clinical personnel.
- In accordance with the operating conditions specified in this manual.
- In original and unmodified shape and only with compatible accessories.

Every other use may lead to risk of personal injury!

### CAUTION!

Read this manual thoroughly so that you completely understand how the Vivo 3 is operated and maintained before taking it into use, to ensure correct usage, maximum performance and serviceability.



Non-professional caregivers (e.g. family members) should consult the medical equipment provider's respiratory therapist if they have any questions about the function, proper use, operation, service or maintenance of the Vivo 3.

U.S. Federal law restricts this device to sale by or on the order of a licensed healthcare practitioner.

### WARNING!



The Vivo 3 is not designed for life support treatment:

- The Vivo 3 should not be used for life support treatment.
- The Vivo 3 should not be used for ventilator dependent patients.

## 1.1 Manufacturer Information

To obtain further technical or regulatory information (including MDS2) about the Vivo 3, please contact Breas technical support.

### Legal Manufacturer

#### Postal Address

Breas Medical AB  
Företagsvägen 1  
SE-435 33 Mölnlycke Sweden

#### Web Address

[www.breas.com](http://www.breas.com)

#### Email address

[breas@breas.com](mailto:breas@breas.com)

#### Phone

+46 31 868800, Order: +46 31 868820, Technical support: +46 31 868860

#### Fax

+46 31 868810

## Americas Sales and Support Information

### Phone

1-855-436-8724 ext 110

### Fax

1-540-301-0881

### Sales and Orders Email

orderUS@breas.com

### Tech Support Email

supportUS@breas.com

## 1.2 What is the Vivo 3?

The Vivo 3 is an internally powered pressure ventilator capable of delivering invasive or non-invasive ventilatory support for the care of individuals who require long-term support from mechanical ventilation for respiratory insufficiency or respiratory failure, with or without obstructive sleep apnea.

### 1.2.1 Non Invasive Interfaces

The ventilator system can be used non-invasively with nasal mask, full/total face mask, and nasal pillow interfaces. The Vivo 3 has been tested with the following interfaces:

- ResMed Airfit F20
- Resmed Airfit N20
- Philips Respironics DreamWear Pillow
- Philips Respironics Wisp Pediatric Nasal Mask

### 1.2.2 Mobility and Usage Environment

The ventilator system is classified as transit-operable and is intended to be used in homes, public spaces, institutions and hospitals.

The ventilator system is intended to be used together with portable applications such as wheelchairs, gurneys or personal family vehicles. It is not intended for use during emergency transports.

### 1.2.3 Continuous Operation

The ventilator can be used for continuous operation up to 24 hours/day at least for 90 days without restarting.

### 1.2.4 Service Life

The expected service life of the Vivo 3 is 5 years or 20,000 hours.

### 1.2.5 High Flow Nasal Therapy Mode

A respiratory humidifier (with supplemental oxygen entrainment) is a humidifier with integrated flow generator that delivers warmed and humidified respiratory gases to spontaneously breathing patients through a variety of patient interfaces.

In comparison, the Vivo 3 device has a (HFNT) high flow nasal therapy mode where a constant flow is delivered regardless of the nature of the connected nasal cannula and patient circuit.



## 1.3 Intended Use

To provide continuous or intermittent ventilatory support for the care of individuals who require mechanical ventilation.

## 1.4 Indications for Use

The Vivo 3 is intended to provide invasive and non-invasive ventilatory support to treat patients weighing over 10 kg (22 lbs) with Respiratory Insufficiency or Respiratory Failure with or without Obstructive Sleep Apnea (OSA). It is intended to be used in the home, institutional/hospital, and portable applications such as wheelchairs and gurneys.

Vivo 3 may provide high flow warmed and humidified respiratory gases to spontaneously breathing adult patients in home and clinical settings, with a flow rate of 4 – 60 L/min depending on patient interface.

## 1.5 Operation by Lay Users

Day-to-day caregivers, patients, relatives and other non-professional users may operate the Vivo 3 with the *Home mode* activated, after it has been set up according to the prescribed treatment. In Home mode, some settings and controls are locked or hidden.

The lay operator may also perform basic maintenance that doesn't require special equipment or a service environment.

### Training

The lay operator shall be trained to basic knowledge of the Vivo 3 and in the specific operations they are assigned to perform. The training shall be based on this user manual and the responsible clinical personnel shall assess the level of training required for each lay operator. This manual shall be available for training and as reference when operating the Vivo 3.

## 1.6 Contraindications

The Vivo 3 is not a life-support ventilator and is contraindicated in patients who are unable to tolerate more than brief interruptions in ventilation.

If a patient has any of the following conditions, therapy with positive airway pressure may be contraindicated and the prescribing clinician shall decide if the benefit of ventilatory assistance outweighs the risks:

- Untreated pneumothorax
- Pneumomediastinum
- Inability to maintain a patent airway or adequately clear excessive respiratory secretions
- Severe acute systemic complications (shock, unstable arrhythmias, myocardial ischemia)
- Severe bullous lung disease
- Risk of vomiting
- Pathologically low blood pressure, especially if associated with intravascular volume depletion
- Cerebrospinal fluid leak, recent cranial surgery or trauma
- HFNC therapy should not delay advanced airway management in a patient deemed to require immediate endotracheal intubation. This may include patients with acutely impaired mental status, risk of aspiration, or other need for airway protection.

The use of the Vivo 3 is contraindicated in an MRI environment.

## Adverse Effects

If the patient experiences chest discomfort, pain, severe headache or shortness of breath while using the Vivo 3, a physician or responsible clinician should be contacted immediately. The following side effects may occur during the course of therapy with the Vivo 3, patients are advised to report any new or changing adverse effects to their physician:

- Nasal, mouth or throat dryness
- Nosebleeds
- Abdominal bloating
- Ear or sinus discomfort
- Eye irritation
- Skin rashes

## 1.7 About this Manual

Firmware described in this manual: 2.2.2

### 1.7.1 Audience

This manual is intended for patients and other lay users operating the Vivo 3.





- Care providers, clinical personnel, physicians and others who require a working knowledge of the Vivo 3 will find additional information on settings and functions in the Clinician's Manual. The Clinician's manual should be of the same revision as the User's Manual.
- Service personnel may order the Service Manual that contains detailed technical information for maintenance, service, repair and disposal procedure. The Service manual's revision is independent of the User's Manual revision.

### 1.7.2 Icons in this Manual

In this manual, icons are used to highlight specific information. The meaning of each icon is explained in the table below.

Icon	Explanation
	<b>Warning!</b> Risk of death or personal injury.
	<b>Warning!</b> Risk of Cross-contamination.
	<b>Warning!</b> Risk of electric shock.
	<b>Warning!</b> Hot surface, risk of burns.
	<b>Warning!</b> Flammable material, risk of fire.
	<b>Caution!</b> Risk of equipment damage, loss of data, extra work, or unexpected results.

Icon	Explanation
	MR Unsafe. The device should not enter a magnetic resonance (MR) environment, such as an MRI scanner room.
	<b>Note</b> Information that may be valuable but is not of critical importance, tips.
	<b>Reference</b> Reference to other manuals with additional information on a specific topic.

## 2 Safety Information

### 2.1 General Use — Warnings and Precautions

#### **WARNING!**

##### **Risk of Personal Injury**

The Vivo 3 is not designed for life support treatment:

- The Vivo 3 should not be used for ventilator dependent patients.

##### **Risk of Faulty Treatment**

If the patient is admitted to a hospital or is prescribed any other form of medical treatment, always inform the medical staff that the patient is on mechanical ventilation treatment.

The Vivo 3 shall not be used with nebulizers.

##### **Risk of Insufficient Ventilation**

Usage outside the specified operating conditions may cause reduced performance.

The Vivo 3 must only be used in accordance with the operating conditions specified in this manual.

##### **Risk of Faulty Treatment**

Do not use the Vivo 3 in the event of:

- Suspected damage to the device, including the occurrence of Internal Functional Failure alarms.
- Unexpected patient symptoms during treatment.
- Unexplainable or sudden changes of pressure, performance or sound during operation.
- Delivered air being abnormally hot or emitting an odor.

Contact your responsible care provider for an inspection.

##### **Risk of Suffocation**

Do not remove the protection for the heated patient circuit connector, the connector can be fitted with the protection in place.

If removed, children can choke or suffocate if swallowing it.

##### **Risk of Asphyxia or Personal Injury**

Using incorrect settings may cause personal injury or severe medical conditions, such as hypercarbia, producing arterial acidemia.

The therapy settings shall be based on a physician's prescription. Changes to settings must be made by authorized clinical personnel only.

##### **Risk of Faulty Treatment**

The responsible organization should periodically reassess the settings of the therapy for effectiveness.

##### **Risk of Faulty Treatment**

Always prepare the Vivo 3 as described in this manual before use.

### **Risk of Unnoticed Critical Conditions**

- All the physiological alarms of the Vivo 3 must be set at safe levels that will effectively warn the user of any risk.  
The alarm levels should be assessed considering the patient's treatment settings.
- Any change of treatment settings or change of components in the ventilation system may require readjustment of the alarm levels.
- The alarm sound level should be set to a clearly audible level. Setting the alarm sound level below that of the ambient sound level can impede recognition of alarm conditions.

### **Risk of Unnoticed Critical Conditions**

When using the Vivo 3 invasively, physiological alarms, such as the low volume alarm and the low breath rate alarm, must be carefully set, to ensure safe use.

### **Risk of Reduced Safety and Performance**

Accessories that have not been verified to be compatible with the Vivo 3 might affect safety features and performance negatively.

Only use the Vivo with accessories that are compatible with the ventilator. Use of incompatible parts to connect the ventilator to the patient can result in degraded performance and change of pressure gradient.

Breas Medical has verified the compatibility between the Vivo 3 and the accessories listed in 10 *Accessories*, page 82.

The responsible organization must ensure the compatibility of the ventilator with all parts used to connect to the patient before starting the intended treatment. If incompatible accessories are used, Breas Medical AB has no responsibility for the safe and effective use of the Vivo 3.

### **WARNING!**

#### **Risk of Electric Shock**

Modifying or using the ventilator with incompatible accessories may cause cardiac arrhythmia.

The Vivo 3 must only be used in original and unmodified shape and only with compatible accessories.

Inadequate use of device or accessories may cause loss of treatment or decreased performance.

### **WARNING!**

#### **Risk of Burns**

Covering breathing tubes with a blanket or heating them with an overhead heater can affect the quality of the therapy or injure the patient.

### **WARNING!**

The Vivo 3 is not intended for use as an Apnea monitor.

### **CAUTION!**

Proper placement and positioning of the patient interface is critical to the consistent operation of this equipment.

Handle the Vivo 3 with care.





Always use the therapeutic pressure setting, as individually determined with the configuration of the equipment and accessories.



Make sure to place and pack the device in a way that prevents unintentional start of the machine.



Due to the internal battery, the Vivo 3 may start if the Start/Stop button is pressed even without the mains being connected.



Do not use the Vivo 3 with nitric oxide, helium or helium mixtures. This may affect patient air flow and volume measurements.



If you suspect that the device has been mistreated, perform a functional check before taking it to use. A basic functional check can be performed as described in 5.5 *Performing Start-up Checks*, page 39. A complete functional check can be performed by an authorized service technician.



The Vivo 3 has not been evaluated for electromagnetic immunity in accordance with Section 20 of RTCA DO-160 (RF immunity, category R). Therefore, please confirm proper device operation before use in the passenger cabin of commercial airplanes.



#### NOTE

Any serious incident that has occurred in relation to this device should be reported to the competent authority and the manufacturer.

## 2.2 Electricity — Warnings and Precautions

### WARNING!

#### Risk of Electric Shock

High voltage contact may cause cardiac arrhythmia.

- Do not operate the Vivo 3 if it has a damaged power cord, power supply or casing.
- To avoid electrical shock, only clean the Vivo 3 according to instructions in this manual. Do not soak or immerse the Vivo 3 into any fluids.
- Use the approved power supply units only.  
Use of unapproved power supply units may compromise the electrical isolation and lead to risk of electric shock.
- Do not use more than one multiple portable socket-outlet or extension cord.  
If a multiple portable socket-outlet is used, it must not be placed on the floor.
- The operator must not touch accessible contacts of connectors and the patient simultaneously.
- Nurse Call must only be connected to a safety extra low voltage system with an isolation from AC power (Mains) voltage which complies with the requirements of IEC 60601-1.



## WARNING!

### Risk of Faulty Treatment

Electromagnetic Interference may cause electrical equipment to malfunction.

- The aspects of electromagnetic compatibility must be considered.
  - The Vivo 3 should not be used adjacent to or stacked with other equipment; if adjacent or stacked use is necessary, the Vivo 3 should be observed to verify normal operation in that configuration.
  - Mobile or transportable radio transmitters may interfere with the Vivo 3.
  - Further guidance for safe installation of the ventilator can be found in the chapter about emission and immunity declaration.
- If a portable AC power supply is used, make sure that the voltage variations are within the operating limits of the Vivo 3.
- Portable RF communications equipment (including peripherals such as antenna cables and external antennas) should be used no closer than 30 cm (12 inches) to any part of the Vivo 3, including cables specified. Otherwise, degradation of the performance of this equipment could result.



## 2.2.1

### Electromagnetic Compatibility and Electrostatic Discharge (EMC and ESD)

Use of accessories, transducers and cables other than those specified or provided by Breas could result in increased electromagnetic emissions or decreased electromagnetic immunity of this equipment and result in improper operation.

Electromagnetic disturbance may impair the safety and performance of the Vivo 3.

Unsteady indicated values for delivered volumes or pressures and the occurrence of alarm conditions without apparent cause may be an indication of loss of performance due to electromagnetic disturbances.

Measures for keeping electromagnetic field levels low should include but are not be limited to:

- Normal precautions with regard to relative humidity and conductive characteristics of clothing in order to minimize the build-up of electrostatic charges.
- Avoiding the use of radio emitting devices (e.g. cellular or cordless telephones, microwave ovens and high-frequency surgery apparatus) closer than 1 meter to the Vivo 3.
- Avoiding the use of known sources of Electromagnetic Interference, (e.g. RFID, diathermy equipment), in the presence of the Vivo 3.

Please note some of these RF emitters may not be visible and the Vivo 3 can potentially be exposed to fields from these RF emitters without the user's awareness. If abnormal performance of the Vivo 3 is observed, and the RF emitters cannot be identified and removed, the Vivo 3 may need to be reoriented or relocated.



See the section 9.4 *Emission and Immunity Declaration*, page 76 for detailed information and further guidance for mitigating electromagnetic disturbance.

## 2.3 Environment — Warnings and Precautions



### WARNING!

#### Risk of Intoxication

Do not use the Vivo 3 in a toxic environment.



#### Risk of Faulty Treatment

If a room humidifier is used, place it at least 2 meters away from the Vivo 3.



#### Risk of Faulty Treatment

 Do not use or store the Vivo 3 in a magnetic resonance (MR) environment. Use of the Vivo 3 in an MR environment may result in malfunction of the Vivo 3 and pose unacceptable risk to the patient, medical staff or other persons.

#### Risk of faulty Treatment

The performance of the Vivo 3 may deteriorate at altitudes or ambient temperatures outside the operation conditions specified in the chapter *Technical Specifications*.

- Do not use the ventilator while positioned in a warm place, such as direct sunlight or close to a radiator as this might lead to temperature outside the specifications.
- Do not use the ventilator in an hyperbaric chamber, as this would cause an ambient pressure outside the specifications.
- Do not use the ventilator immediately after storage or transport outside the recommended operating conditions.



### WARNING!

#### Risk of Fire

Do not use the Vivo 3 in environments where explosive gases or flammable anesthetic agents present.



### WARNING!

#### Risk of Electric Shock

Water on and in the device may cause an electric conductive path. Do not expose the Vivo 3 to rain or snowfall.



### CAUTION!

The ventilator, any accessories and all replaced parts, must be disposed of in accordance with the local environmental regulations regarding the disposal of used equipment and waste.

## 2.4 Patient Circuit — Warnings and Precautions



### WARNING!

#### Risk of Insufficient Ventilation

Insufficient ventilation may cause transient hypoxia.

The Vivo 3 ventilator is intended to be used with patient circuits with intentional leakage and compliant to ISO 17510. Recommended leak rate: 20 to 50 liters per minute at 10 cmH<sub>2</sub>O.

Failure to use a mask or accessory that minimizes rebreathing of carbon dioxide or permits spontaneous breathing can cause asphyxiation.





### **Risk of Abnormal Exhalation Volume Measurement**

Non-invasive ventilation: The exhaled volume of the patient can differ from the measured exhaled volume due to unintentional leaks around the mask.

Invasive ventilation: The exhaled volume of the patient can differ from the measured exhaled volume due to unintentional leaks around the cannula.

For correct measurements, minimize unintentional leaks.



### **Risk of Reduced Performance**

Filters and patient connected parts must be replaced regularly to ensure correct function of the Vivo 3.

### **Risk of Insufficient Ventilation**

Insufficient ventilation may cause transient hypoxia.

Before use:

- Make sure that the patient circuit and joined parts are undamaged and correctly connected, in order to avoid unwanted leakage.
- The leakage port of the patient circuit or patient interface prevents rebreathing by flushing the exhaled air. It should be located as near the patient interface as possible (this is even more important for treatments with low pressure). Make sure that it is not blocked or obstructed.
- The Vivo 3 should be turned on and the function of the leakage port should be checked before use:



### **Risk of Insufficient Ventilation**

Incompatible patient circuits may come loose.

To prevent disconnection of the patient circuit or patient circuit system during use, especially during ambulatory use, only patient circuits in compliance with ISO 5367 or ISO 80601-2-74.



### **Risk of Suffocation**

Periodically check for moisture in the patient circuit.

When present, remove the moisture. Before attempting to dry the circuit, disconnect it from the Vivo 3 to ensure no water flows back into the Vivo 3.

The frequency at which these checks must be performed will depend on the patient's condition and the device used. The responsible caregiver should assess this on an individual basis in accordance with the patient's needs.



### **Risk of Suffocation**

If the patient needs assistance to remove the patient interface, the patient shall not be left alone. This is to avoid the risk of re-breathing of CO<sub>2</sub> in case of accidental ventilator failure.

Do not breathe through the connected patient circuit unless the ventilator is turned on and operating properly.



### **Risk of Suffocation**

If the patient is using a full face mask (covering mouth and nose), the mask must be equipped with a safety entrainment valve.



### **Risk of Suffocation or Barotrauma**

In HFNT mode, do not use a sealed patient interface.



### **Risk of Constriction**

Entanglement with cables or tubing constricting airways may cause asphyxiation.

Do not leave long lengths of air tubing or cables around the top of the bed. They could twist around the patient's head or neck while sleeping.





### **Risk of Insufficient Ventilation**

Insufficient ventilation may cause transient hypoxia.

The use of equipment such as endotracheal tubes, oral/nasal tubes, adaptors etc. with small inner diameters or high resistance filters, humidifiers etc. increase the resistance in the patient circuit which may interfere with the operation of the patient disconnect function. It may also interfere with the device trigger function.



### **WARNING!**

#### **Risk of Electric Shock**

Do not use antistatic or electrically conductive hoses or tubing with the ventilator breathing system. This could result in electrical shock.



### **WARNING!**

#### **Risk of Cross-Contamination**

Patient circuits might get contaminated by exhaled gases. To avoid cross-contamination, always use a new patient circuit when the Vivo 3 is to be used by a new patient.



### **NOTE**

For masks and accessories, always follow the manufacturer's instructions.

## **2.5 Filter Usage — Warnings and Precautions**

Low resistance bacteria filter, if used, should be replaced every 24 hours.

### **WARNING!**

#### **Risk of Overheating**

Replace or clean the air inlet filters as specified in the *Maintenance* chapter.

Using old or clogged filters may cause the Vivo 3 to operate at higher temperatures than intended.

When operating the Vivo 3, make sure that the air inlet and filters are not obstructed or occluded.



#### **Risk of Insufficient Ventilation**

Insufficient ventilation may cause transient hypoxia.

Do not use high resistance bacteria filter at the air outlet of the Vivo 3. High resistance bacteria filters placed between the air outlet and the patient interface may interfere with the operation of the patient disconnect function. It may also interfere with the device trigger function.



#### **Risk of Insufficient Ventilation**

Humidification can increase the resistance of breathing system filters and the operator must monitor the breathing system filter frequently for increased resistance and blockage to ensure the delivery of the therapeutic pressure.

Increased resistance may interfere with the operation of the patient disconnected function.



### **WARNING!**

#### **Risk of Cross-Contamination**

Deep tissue or mucosal contact with infectious agents may cause infections:

- If assigning the Vivo 3 to a new patient, always replace the filters.
- Always use the Vivo 3 with patient air inlet filters installed.





### **Risk of Cross-Contamination**

Deep tissue or mucosal contact with infectious agents may cause infections. If the Vivo 3 is used by several patients, a low resistance bacteria filter shall be used between the air outlet and the patient circuit, for preventing patient cross-contamination. Reuse of bacteria filter, patient circuit or mask may expose patients to contagious agents.

## **2.6 Invasive Use — Warnings and Precautions**

### **WARNING!**



#### **Risk of Faulty Treatment**

If using the Vivo 3 for invasive ventilation, humidification is recommended. Make sure to use an external heated humidifier that complies to invasive use according to ISO 80601-2-74.

The attachable humidifier is not intended for invasive use.



#### **Risk of Unnoticed Critical Conditions**

When using the Vivo 3 invasively, physiological alarms, such as the low volume alarm and the low breath rate alarm, must be carefully set, to ensure safe use.

#### **Risk of Rebreathing**

Be aware of risks for rebreathing exhaled gases:

- A blocked, clogged or in other ways occluded leakage port causes exhaled gases to be rebreathed.
- With low pressures the risk of rebreathing increases.
- I:E (inspiration time : expiration time) ratios close to 1:1 increase the risk of rebreathing as the expiratory time allowing exhaled gases to be cleared from the circuit before the next breath is decreased.



The Vivo 3 is equipped with a low leakage alarm. However, the alarm is not a substitute for operator vigilance for ensuring that the leakage ports remains clear at all times.

Periodically check the leakage ports during therapy.

See the section 2.4 *Patient Circuit — Warnings and Precautions*, page 14 for mitigating the risks of rebreathing.

## **2.7 Humidification and Heating — Warnings and Precautions**

### **WARNING!**



#### **Risk of Personal Injury**

The attachable humidifier shall not be used with nitric oxide. Such use might cause the humidifier to not function correctly, causing serious deterioration of health.

#### **Risk of Suffocation**

When the attachable humidifier is installed, the Vivo 3 must be located below the patient and on a flat surface. This is to prevent personal injury from accidental spillage or from excess water or condensation flowing down the patient tube and into the patient's mask. Extra cautions should be taken for patients who are unable to guard their airways or cannot pull off the mask.





### **Risk of Suffocation or Loss of Ventilation**

Incorrect placing of the ventilator may cause transient hypoxia.

If using an external humidifier, it shall be placed below both the patient and the Vivo 3.

This is to prevent personal injury from accidental spillage or from excess water or condensation flowing down to the ventilator or down the patient tube and into the patient's mask. Extra cautions should be taken for patients who are unable to guard their airways or cannot pull off the mask.



### **Risk of Inflammation**

Incorrect connection of the ventilator may cause inflammation.



### **Risk of Suffocation**

Installation of a water trap may be required if the condensation is extensive in the patient circuit when using a heated humidifier.

The water trap prevents condensed water in the patient circuit from reaching the patient airways and causing personal injury.



### **Risk of Suffocation or Electric Shock**

Do not use the attachable humidifier during mobile use.

Due to movements, water spillage from the humidifier or condensed water may cause suffocation or electric shock.

## **WARNING!**



### **Risk of Electric Shock**

Do not transport the ventilator with water in the humidifier.

The attachable humidifier must be detached before filling. Do not fill above the *Maximum Water Level* indication on the water chamber.

Electrostatic discharge or contact with leakage current may cause an electric shock.



## **WARNING!**

### **Risk of Burns**

After using the ventilator, wait one minute before you open the water chamber since it can get hot under certain conditions (for example if the humidifier runs out of water).



## **CAUTION!**

The use of external humidifier may require readjustment of the low-pressure alarm.

## **2.8 Cleaning and Maintenance — Warning and Precautions**

This manual contains instructions for cleaning and maintenance that can be carried out by the care provider or users with physical ability and working knowledge of the system.



## **WARNING!**

### **Risk of Faulty Treatment**

Service and Maintenance of the Vivo 3 shall not be performed when the Vivo 3 is in use.



## **WARNING!**

### **Risk of Electric Shock**

Cleaning with excessive water or opening the device's casing without certified training may cause electric shocks.

The Vivo 3 should be regularly cleaned and maintained in accordance with this operating manual.

**Risk of Electric Shock**

High voltage contact may cause cardiac arrhythmia.

Repairs and modifications must be carried out by authorized technicians only and in accordance with instructions from Breas Medical AB

- The Vivo 3 must not be opened, repaired or modified by unauthorized personnel or interconnected with incompatible equipment. If subjected to unauthorized modifications or operations, Breas Medical AB is no longer responsible for the device's performance and safety and all warranties will become invalid.

**CAUTION!**

Do not attempt to autoclave or sterilize the Vivo 3.

## 2.9 Oxygen Usage — Warning and Precautions

When using the Vivo 3 with oxygen, always follow the oxygen provider's instructions and use only medical grade oxygen complying with local regulations.

### **WARNING!**

#### **Risk of faulty Treatment**

At a fixed flow rate of supplemental oxygen flow, the inhaled oxygen concentration will vary, depending on the pressure or flow delivered, the patient interface and leak rate. To monitor the oxygen concentration, use an external patient air oxygen saturation monitoring unit which complies with ISO 80601-2-55 and is equipped with a high oxygen level alarm.

#### **Risk of faulty Treatment**

The responsible organization shall ensure that the oxygen source is compatible with the rated range of pressure, flowrate and oxygen concentration for this device.

Failure to use a compatible oxygen source may result in serious deterioration of health.

#### **Risk of faulty Treatment**

When administering supplemental oxygen, appropriate patient monitoring should be used, as medically indicated, such as an alarming pulse oximeter.

### **WARNING!**

#### **Risk of Fire**

The presence of oxygen can speed up combustion of inflammable materials.

- Turn the oxygen supply off when the ventilator is not delivering treatment. Oxygen may otherwise accumulate in the enclosure and increase the risk of fire.
- When the oxygen supply is turned on, never leave the patient interface on textiles like bed coverings or chair cushions. The oxygen enrichment will make the materials more flammable.
- Use only water-based lotions or salves that are oxygen-compatible before and during oxygen therapy. Never use petroleum-based or oil-based lotions or salves, to avoid the risk of fire and burns.
- Covering breathing tubes with a blanket or heating them with an overhead heater can affect the quality of the therapy or injure the patient.
- Ventilate the room adequately.
- Do not smoke in a room where oxygen is being used, it may result in facial burns or death. If the patient intends to smoke: turn the equipment off, remove the patient interface and leave the room where the equipment is located before smoking. If unable to leave the room, wait 10 minutes after you have turned the equipment off.
- Naked light bulbs, open flames and other sources of ignition must be kept a minimum of 2 meters (6 feet) away from the oxygen cylinder or any oxygen carrying parts and accessories.
- Do not use aerosols or solvents close to the oxygen supply, even when the oxygen supply is shut off.
- Do not lubricate fittings, connections, tubing, or other accessories of the equipment as the lubrication might be flammable in combination with the oxygen rich gas flow.

## 2.10 Mobile Use — Warning and Precautions

This section applies if using the Vivo 3 during transit, for example on a wheel chair or in a car.

### **WARNING!**

#### **Risk of faulty treatment and electric shock**

If connecting the Vivo 3 to a portable AC power generator, make sure its voltage variations are within the operating limits of the Vivo 3.

For external DC power, always use the DC/DC power supply adapter (accessory). Do not connect the ventilator directly to the battery of a wheelchair or any other external DC power source as this may:

- Compromise the electrical insulation and lead to electric shock
- Result in unintended interruptions of the ventilation.
- Compromise the ventilator performance and result in degradation of the health of the patient.



### **CAUTION!**

During mobile use, protect the device with either of the Protective Cover accessory or the Lightweight Mobility Bag accessory. Do not use the Vivo 3 while in a carry bag.



### 3 Product Description

This section describes the main Vivo 3 medical electric equipment.

For information about accessories, see <http://www.breas.com>

#### 3.1 Overview

This overview shows the ventilator with operator detachable parts connected. For detailed information about connecting parts and accessories, see 5 *Prepare the Vivo 3 for Use*, page 37 and 6.6 *Using Accessories*, page 44.

1. Ventilator unit
2. Filter holder with air inlet filter
3. Power Supply
4. Patient Circuit
5. Air bypass unit. May be replaced by the attachable humidifier (accessory)

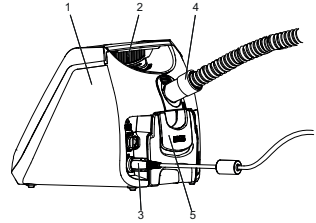

#### 3.2 Ventilator Front

This section describes the front panel.

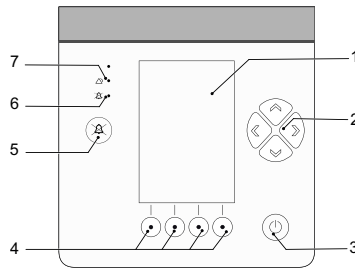

1. **Screen**, displays pages with information, settings and commands.
2. **Directional buttons**, moves between and selects objects on the current page.
3. **On/Off button**, starts /stops treatment or turns the ventilator On/Off.
4. **Navigation buttons**, select pages according to the corresponding label on the display. The navigation buttons can temporarily be designated functions for replying to questions or requests from event windows.
5. **Audio pause button**, pauses the alarm sound.
6. **Audio Pause LED**, lights yellow when the alarm sound is paused.
7. **Alarm LED**, flashes during active alarms.



### 3.3 Ventilator Back

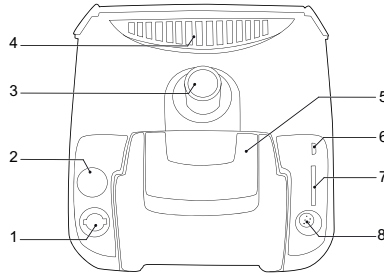

1. **Power port**, for connecting the power supply.
2. Not used port
3. **Patient air outlet**, connection for patient circuit
4. **Patient air inlet**, with filter holder
5. **Air bypass module**, directs the patient air flow. Removed if the attachable humidifier is used.
6. **USB port**, for data transfer to a PC.
7. **SD Card port**, for copying records and logs to a PC.
8. **Communication port**, for connection of accessories.

The ventilator can be carried by hand using the handle.

### 3.4 Power Management

#### WARNING!

##### Risk of faulty treatment and electric shock

If connecting the Vivo 3 to a portable AC power generator, make sure its voltage variations are within the operating limits of the Vivo 3.

For external DC power, always use the DC/DC power supply adapter (accessory). Do not connect the ventilator directly to the battery of a wheelchair or any other external DC power source as this may:



- Compromise the electrical insulation and lead to electric shock
- Result in unintended interruptions of the ventilation.
- Compromise the ventilator performance and result in degradation of the health of the patient.

The Vivo 3 has a power management system that automatically selects the best available power source, according to the priority list below:

1. Mains power via Breas Mains power supply
2. External DC via the Breas DC/DC power supply adapter
3. Internal battery



The power source is indicated by a symbol at the top of the display.



Power Source	Icon
Mains	
External DC	
Internal battery	

For connecting the Vivo 3 to both mains and external DC at the same time, the accessory *Power supply Y-cable* is required.

If a power source fails, the Vivo 3 will switch to the next source in priority and show a message on the display. If all available sources fail, the *Power Failure* alarm is given and the Vivo 3 shuts down.

### Charging the Internal Battery

The internal battery is automatically charged when the Vivo 3 is connected to external power. The state of charge is indicated by a symbol on the display. The green part of the battery shows the state of charge.

Battery State of Charge	Icon
High	
Charging	

### Preparing the Battery for Storage

If storing the Vivo 3, longer than 1 month, make sure that the internal battery is about half charged before storing, in order to maintain maximum battery capacity. Optimal storage temperature is 5 to 30°C (41 to 86°F).

## 3.5 Menus

### 3.5.1 Use the Menu

The menu consists of four function sections:

- Monitor
- Setup
- Alarm
- Others

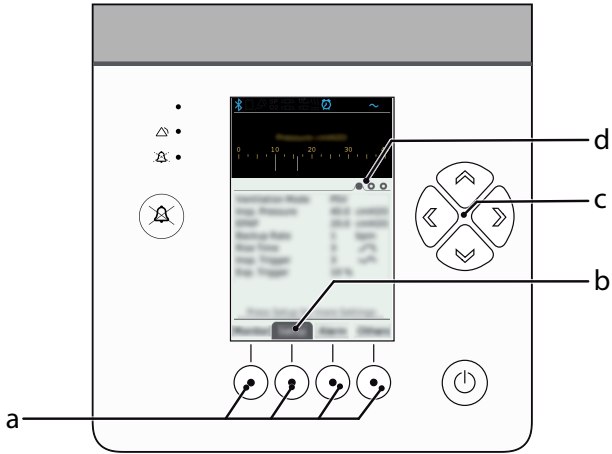

- a. Navigation buttons
- b. Active page indicator
- c. Directional buttons
- d. Page number indicator (for functions with several pages)

### Selecting the Section to Display

**1** Press the navigation button for the requested function page.

⇒The page is now displayed.

**2** For functions with several pages grouped together, press the navigation button again to browse the pages.

**3** For pages with menus, settings or additional information, press the Up and Down arrow buttons to select an item on the page.

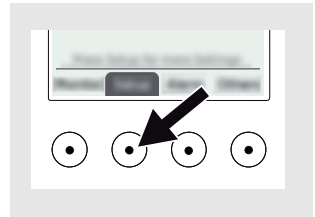

## Select an Item on a Page

This procedure describes how to navigate between selectable items. Read-only information cannot be selected.

### Selectable Items

- Sub pages (indicated by an arrow to the right of the item text)
- Settings
- Commands

1 Press the Up or Down arrow button to select the first selectable item on the page.

⇒ The selected item is highlighted.

2 To select another item on the list, press the Up or Down arrow until it is highlighted.

Note that items with read only information cannot be selected.

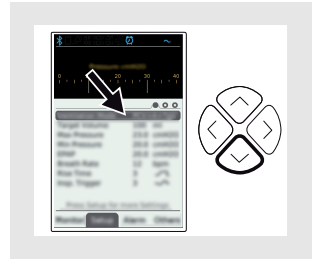

## Enter a Sub Page

1 Select the sub page (indicated by an arrow to the right of the item text) using the Up or Down arrow button.

2 Enter the sub page by pressing the right arrow button.

⇒ The sub page is now displayed.

3 Leave the sub page using the left arrow button

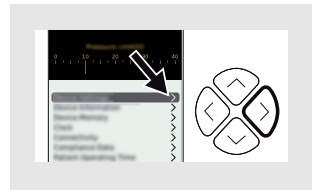

## Change a Setting

1 Select the setting (indicated by an arrow to the right of the item text) using the Up or Down arrow button.

2 Change the setting using the right or left arrow buttons to select between the predefined values.

⇒ The currently displayed value will remain selected when leaving the page.

3 Leave the sub page using the navigation buttons.

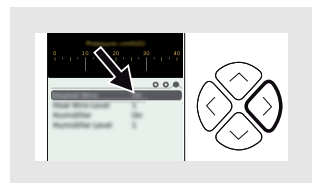

## Execute a Command

1 To execute a command, select it and press the right arrow button.

⇒ The command execution is started. Additional actions related to the command might be requested in event windows.

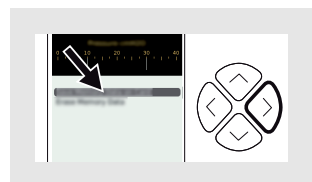

### 3.5.2 The Monitor Page

The monitor page displays the treatment data. It consists of a bar graph illustrating the current pressure and text area displaying current monitored values in text. See also 6.5.1 *Treatment Values Monitored by the Vivo 3*, page 44.

#### Bar graph legend

1. Current pressure
2. Low pressure alarm level
3. Set inspiration pressure level
4. High pressure alarm level

#### Monitor page with HFNT

When HFNT is active, flow is displayed instead of pressure.

#### Monitor page with HFNT

When HFNT is active, flow is displayed instead of pressure.

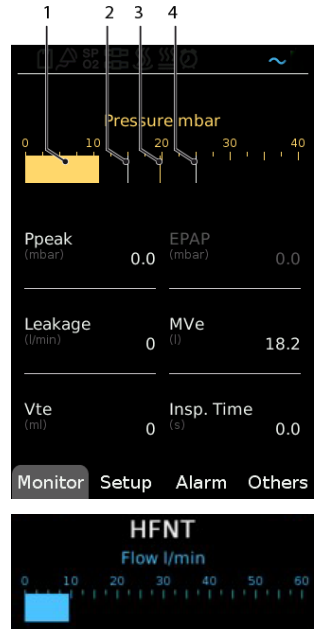

### 3.5.3 The Setup Pages

The setup pages contain settings related to the treatment.

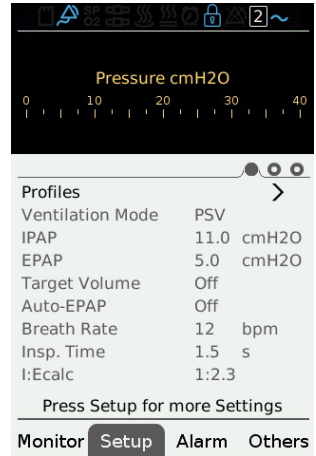

#### Selecting a profile

If profiles with preset treatment settings have been created, the profiles are selected from the Setup section.

- 1 Select Profiles and press the Down or Up arrow button to select one of the profiles.
- 2 Press Left arrow button to select a profile. The currently active profile is indicated by a checkmark.



For detailed information about each setting, see 4 *Treatment Functions and Settings*, page 35.

### 3.5.4 The Alarm Pages

The alarm pages contain alarm settings and an alarm history list.

For information about the alarms and their possible settings, see 7 *Alarms*, page 54.

### 3.5.5 The Others Pages

The Others pages contain non-clinical settings and information.

### 3.5.5.1 Device Settings

This section describes device settings that don't affect the ventilating function of the Vivo 3.

Setting	Description
Language	<b>Value range:</b> The available languages are listed with their native names accompanied by a flag representing a country where the language is spoken. <b>Default value:</b> English (The language selection menu is displayed when the Vivo 3 is started for the first time.)
Confirm Start/Stop	If set to On, the user need to confirm that the treatment is to be stopped. If set to Off, treatment is started and stopped directly when pushing the start/stop button on the machine. Default value: On
Pressure Unit	<b>Value range:</b> <ul style="list-style-type: none"><li>• cmH<sub>2</sub>O</li><li>• mbar</li><li>• hPa</li></ul> <b>Default value:</b> cmH <sub>2</sub> O
Display Light	<b>Value range:</b> <ul style="list-style-type: none"><li>• On — Always lit at the selected intensity</li><li>• Auto — Always lit, with automatic adjustment of the intensity with regards to the ambient light.</li><li>• Delayed — The display is dimmed after about 30 seconds (time depends on usage mode and power source). If any button is pressed or any alarm occurs, the display is lit again.</li></ul> <b>Default value:</b> On
Light Intensity	<b>Value range:</b> 1 to 5 <b>Default value:</b> 5

### 3.5.5.2 Pre-use Test

The pre-use test checks that the patient circuits resistance, compliance and leakage are compatible with the Vivo 3.

For custom patient circuits, the pre-us test shall be performed the patient circuit is used for treatment After the pre-use test, measured resistance and compliance for the custom patient circuit will be saved and used for optimizing the treatment.

The pre-use test is performed using a guide in the graphical user interface.

### 3.5.5.3 Device Information

Information	Description
Product name	
Operating time	The total number of hours the ventilator has been running in operating mode.
Battery Percentage	Battery charge level
Battery Time Left	Estimated remaining usage time on battery power
Software module versions	Technical information for service personnel

### 3.5.5.4 Device Memory

Command	Description
Save Memory Data on Card	Copies the memory data from the internal memory to the memory card.
Erase Memory Data	Erases memory data from the internal memory
Remove SD-card	Remove the SD-card from the ventilator. (It must be ejected manually, though.)

### 3.5.5.5 Clock

Setting	Description
Time	Sets the time for the Vivo 3. The time is used for logs and reports.
Date	Sets the date for the Vivo 3. The date is used for logs and reports.
Time Format	Select whether to use 12 hr clock or 24 hr clock.
Date Format	Select the date format to use.
Alarm Clock	Activates an alarm clock on the Vivo 3. One short signal every 5 seconds.
Alarm Clock Time	Sets the alarm time for the alarm clock.
Alarm Clock Volume	Sets the volume for the alarm clock.



#### NOTE



The alarm clock works only when the ventilator is running on mains.

















### 3.5.5.6 Compliance Data

Setting / information	Description
Period	Period of time to view data.
Min daily use	The minimum daily use, in hours, to reach compliance per day.
Reset Compliance Data	Reset of data.
Start Date	Start date for treatment.
Total Usage Hours	The total number of hours the ventilator has been running in operating mode during the download period.
Total Days	The total number of days in the download period.
Days with Usage	The number of days in the download period where the ventilator has been running in operating mode (all day, or part of the day).
Average Usage Hours	The average number of hours per day the ventilator has been running in operating mode. Only days where the ventilator has been running in operating mode are part of the value (days without treatment are excluded in the calculation).
Days Compliant	Number and percentage of days when minimum daily use has been reached.
IPAP	Average IPAP for selected period.
EPAP	Average EPAP for selected period.
Leakage	Average Total Leak for selected period.
Vte	Average Vte for selected period.
MVe	Average Mve for selected period.
Total Rate	Average Total Respiratory rate for selected period.
% Spont Breaths	Average % Spontaneous breaths for selected period.
Insp Time	Average Inspiratory Time for selected period.
I:E	Average I:E Ratio for selected period.
*) The displayed value is rounded to the nearest whole number.	















### 3.6 Symbols on the Vivo 3

Symbol	Description
	Manufacturer information
	Nemko certification mark (NRTL/SCC accredited)
<b>IP22</b>	Degree of protection provided by enclosure. See 9.3 <i>Operating Conditions</i> , page 75 for explanation.

Symbol	Description
<b>Rx Only</b>	Caution: U.S. Federal law restricts this device to sale by or on the order of a licensed healthcare practitioner. (Symbol only applicable in U.S.)
	Read user instructions
	RTCA/DO-160 G categorization. Category M This category is defined for equipment and interconnected wiring located in areas where apertures are electro-magnetically significant and not directly in view of radio receiver's antenna. This category may be suitable for equipment and associated interconnecting wiring located in the passenger cabin or in the cockpit of a transport aircraft.
	Meets all requirements for CE marking according to relevant European health, safety and environmental protection legislation.
	Meets all requirements for UKCA marking according to applicable United Kingdom health, safety and environmental protection legislation.
	Internal Battery Information
	Read the "Disposal" section for information about recycling and disposal, see 73.
	Product number
	Serial number
	This product is a Medical Device.
	Date of manufacture
	Power connection port. Use approved power supplies only.
	USB port
	SD memory card port
	I/O port for accessory box/SpO <sub>2</sub>

## Additional Symbols on Parts and Accessories

This section describes additional symbols for Vivo 3 detachable parts and accessories from Breas Medical AB. Each item, or its package, have the symbols that applies for the specific accessory.

Symbol	Description
	Caution, hot surface
	Caution symbol, read the Accessory's instructions for more information.
	Keep away from rain.
	Single patient multiple use.
	Meets all requirements for CE marking according to relevant European health, safety and environmental protection legislation.
	Meets all requirements for UKCA marking according to applicable United Kingdom health, safety and environmental protection legislation.
	Applied part, type BF Electrically connected to the patient but not directly to the heart.
	IEC protection Class II: Double insulated equipment.
	Remote alarm port
	Alarm nurse call port
	Effort belt port (not used)
	AC power port
	DC power port
	SPO <sub>2</sub> port

### 3.7 Symbols on the Display



1. SD card inserted and working.
2. SD card failure. For more information, see 6.7 *Basic Troubleshooting*, page 53.
3. Nurse call connected
4. Remote alarm connected
5. SpO2 connected
6. Humidifier activated
7. Heated circuit activated
8. “Clock radio wake up” activated
9. All alarms shut off
10. Active profile
11. Powered by AC power (mains).
12. Powered by external DC source (no AC or DC icon = powered by internal battery) .
13. Internal battery status (red — yellow — green). A flash indicates charging.

## 4 Treatment Functions and Settings

This chapter describes the modes, settings and parameters that controls the ventilation of the Vivo 3.

All stated tolerances includes measurement uncertainty. The accuracies have been tested with all allowed configurations. Stated tolerances only disclose the maximum tolerance. If a parameter's tolerance is described with both absolute and relative measures, the greater one applies.

Lay operators must only use the User Manual, not the Clinician's Manual.

### 4.1 Treatment Settings

This section describes settings and parameters that affects the ventilating function of the Vivo 3. On the machine, these settings are in the **Settings** menu.

#### 4.1.1 Ramp Up

The ramp up setting defines a ramp time for increasing the airway pressures.

At the beginning of Ramp Up time, IPAP will start at 2 cmH<sub>2</sub>O above the configured Ramp Pressure. If the Ramp Pressure was set below EPAP, the EPAP pressure will start at the configured Ramp Pressure.

Unit	Min	Max	Default	Resolution	Tolerance
Minutes	10 Off	60	Off	10	5 %

#### 4.1.2 Ramp Down

The ramp Down setting defines a ramp time for decreasing the airway pressures.

At the end of Ramp Down time, IPAP will end at 2 cmH<sub>2</sub>O above the configured Ramp Pressure. If the Ramp Pressure was set below EPAP, the EPAP pressure will end at the configured Ramp Pressure.

Unit	Min	Max	Default	Resolution	Tolerance
Minutes	10 Off	60	Off	10	5 %

#### 4.1.3 Humidifier

This setting defines whether the attachable humidifier shall be used. If using an external humidifier, this setting shall be *Off*.

The attachable humidifier cannot be used in HFNT mode. The High Flow Nasal Therapy (HFNT) mode requires use of an external humidifier that conforms with ISO 80601-2-74:2021, class 3.

#### **WARNING!**



Read the section 2.7 *Humidification and Heating — Warnings and Precautions*, page 17 before activating the humidifier, to make sure all conditions are met and considered.

Min	Max	Default
Off	On	Off

#### 4.1.4 Humidifier Level

This setting defines the level of humidification, if *Humidifier* is set to *On*.

Min	Max	Default
1	5	1

#### 4.1.5 Heated Circuit

This setting defines whether a heated patient circuit shall be used as patient circuit.

The Heated circuit for Vivo 123 cannot be used in HFNT mode. Always check with the manufacturer for the external humidifier that is used.



**WARNING!**

Read the section 2.7 *Humidification and Heating — Warnings and Precautions*, page 17 before activating the heated circuit, to make sure all conditions are met and considered.

Min	Max	Default
Off	On	Off

#### 4.1.6 Heated Circuit Level

This setting defines the heating level, if *Heated Circuit* is set to *On*.

Min	Max	Default
1	5	1

## 5 Prepare the Vivo 3 for Use

### 5.1 Checking the Vivo 3 before First Use

Before using the Vivo 3, perform the following checks.

- 1 Ensure that the equipment is in good condition.
- 2 If stored more than 1 month, connect the Vivo 3 to the power supply to recharge the internal battery.
- 3 Check that the air inlet filters are installed.

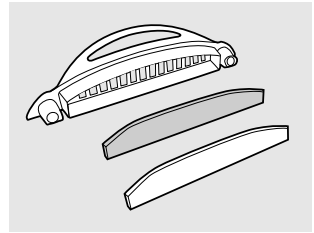

### 5.2 Placing the Vivo 3



#### **WARNING!**

Read the chapter 2.3 *Environment — Warnings and Precautions*, page 14 carefully to make sure all conditions are met and considered.

- 1 Place the Vivo 3 on a solid, flat surface. The Vivo 3 should be placed lower than the patient in order to prevent the device from falling on the patient, as well as preventing condensed water from reaching the patient.
- 2 Make sure that nothing can block the patient air inlet at the back of the Vivo 3, such as a curtain etc.
- 3 Make sure that the controls are accessible for the operator.

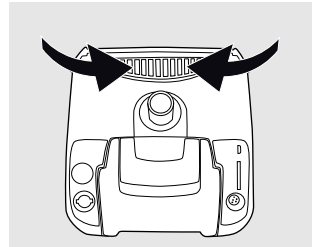
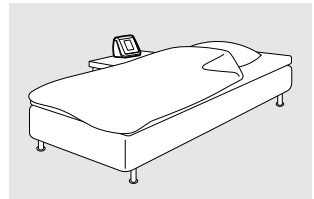

### 5.3 Connecting the Vivo 3 to Power Supply

This chapter describes how to connect a Breas power supply.



#### **WARNING!**

Read the chapter 2.2 *Electricity — Warnings and Precautions*, page 12 carefully to make sure all conditions are considered and met.



#### **CAUTION!**

Isolation from external power sources is provided by the approved AC/DC and DC/DC adapters. The ventilator must only be powered by the approved accessories, see 10.2 *Power Accessories*, page 83.

- 1 Plug the power supply's connector into the power port at the back of the Vivo 3 (a).
- 2 Turn the connector clockwise 90 degrees (b).
- 3
  - If using the AC/DC power supply, connect the AC plug to the mains supply outlet.
  - If using DC/DC adapter, connect the DC plug to the external DC source.
- 4 Make sure that the power outlet is not blocked, so that the cord can be unplugged without difficulties.

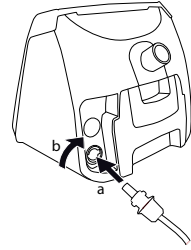

## 5.4 Connecting the Patient Circuit



### WARNING!

Read the chapter 2.4 *Patient Circuit — Warnings and Precautions*, page 14 Carefully to make sure all conditions are considered and met.



### WARNING!

If the Vivo 3 is to be used by more than one patient, a bacterial filter shall be fitted at the patient air outlet to prevent cross-contamination.

The Vivo 3 is intended to be used with leakage circuits only. Recommended leak rate: 20 to 50 liters per minute at 10 cmH<sub>2</sub>O.

- 1 Check that the circuit is clean and undamaged.
- 2 Connect the tube to the air outlet.

If having a heated circuit, make sure to connect the end with the heating plug to the to the air outlet. Refer to 5.4.1 *Connect the Heated Patient Circuit*, page 38 and 5.4.2 *Disconnect the Heated Patient Circuit from the Ventilator*, page 39.

- 3 Check whether the patient interface has an integrated leakage port.
  - If yes, connect the patient circuit to the patient interface.
  - If no, first connect a leakage valve to the patient circuit, then connect it to the patient interface.



A bacterial filter can be attached on the ventilator outlet connector.

### 5.4.1 Connect the Heated Patient Circuit

- 1 Check the patient circuit for damages.
- 2 Go to Setup to define which circuit is being used. See .
- 3 Connect the ventilator cuff to the air outlet of the ventilator. A clicking sound is heard when the latches are fitted correctly.
- 4 If applicable, perform a pre-use test on the ventilator. See 3.5.5.2 *Pre-use Test*, page 29.
- 5 Connect the patient interface cuff to the patient interface.
- 6 On the ventilator, activate the circuit heating.

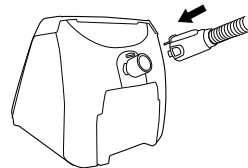



## 5.4.2 Disconnect the Heated Patient Circuit from the Ventilator

1 Disconnect from the ventilator:

Press the latches and pull the circuit off from the ventilator. Do not pull by the tube.

2 Disconnect from the patient interface:

Hold by the cuff and pull the circuit off from the patient interface. Do not pull by the tube.

## 5.5 Performing Start-up Checks

This procedure may be performed as a functional pre-use check at start-up.

### Procedure

#### Prerequisites

- The Vivo 3 shall be connected to the power supply.

1

Start the treatment.

- If *Confirm Start/Stop* is *Off*, press **On/Off** button shortly.
- If *Confirm Start/Stop* is *On*, press and hold the **On/Off** button until the *Starting Treatment* progress bar is filled.

For information about setting the *Confirm Start/Stop* options, see 3.5.5.1 *Device Settings*, page 29 and 6.2 *Start the Treatment*, page 41.

2 When starting treatment, an automatic alarm signal test is performed. Check that the test is performed successfully, this is indicated by:

- A short beep indicating functional audio signaling.
- The alarm LED first lights yellow, then red, indicating functional visual signaling.
- The audio pause LED lights yellow.
- In about a second, both LEDs are turned off.

If the test fails, do not use the Vivo 3. Contact your supplier of the Vivo 3 for a technical check.

3 Disconnect the power cord for more than 5 seconds.

Check that the device switches to the internal battery and that the information message *Switched to Internal Battery* is shown on the screen.

If not, contact your supplier of the Vivo 3.

4 Reconnect the power cord.

Check that the Vivo 3 switches to the mains supply.

If not, contact your supplier of the Vivo 3.

## 5.6 Performing a Pre-Use Test

The pre-use test is used for detecting the characteristics of the patient circuit that is connected to the ventilator. The resistance and compliance of the patient circuit are measured and calculated. This will be used to compensate for pressure drop in the patient circuit and the compliance of the patient circuit.

The patient shall not be connected during the pre-use test.

- The ventilator shall be in stand by mode.
  - The patient circuit to use for the treatment shall be at hand.
- 1 On the **Others** menu, select **Pre-use Test** and then press **OK** to confirm the start of the pre-use test.
  - 2 Follow the instructions on the display and review the results at the end of the test.

### 5.6.1 Actions At Pre-Use Test Failure

At the end of the pre-use test the individual results for leakage, resistance and compliance are shown.

#### Failure Due To Incorrect Leakage

Indication: **Leakage: Fail**

- 1 Check the ventilator set-up (circuit, filters, humidifier, etc.) for leakage.
- 2 Ensure that all connectors are tightly fitting.
- 3 Run the pre-use test again.
- 4 Replace the circuit if the test is failed repeatedly.

#### Failure Due To Incorrect Resistance or Compliance

Indication: **Resistance: Fail** or **Compliance: Fail**

- 1 Check the ventilator set-up (circuit, filters, humidifier, etc.) for blockage or pinched tubing.
- 2 Run the pre-use test again.

If the pre-use test is continually failed due to resistance or compliance, it is permitted to use the ventilator but be aware that the pressure (resistance) or volume (compliance) delivered to the patient may not meet with the specified accuracy.

The ventilator will apply the default values to compensate for circuit resistance and compliance. These values will deviate from the values for the circuit in use.

Ensure that the delivered ventilation is closely monitored.

## 6 How to Use the Vivo 3

For a summary description of the means of initiating and terminating the inspiratory phase in each mode of the ventilator, please refer to .

### 6.1 Switch On the Vivo 3

- **Switching on an unpowered ventilator**

Connect the power supply.

⇒The ventilator starts up and enters standby mode.

If the power supply is connected during the *Power Failure* alarm, the ventilator will start the treatment directly instead of entering standby mode.

- **Switch on a powered ventilator**

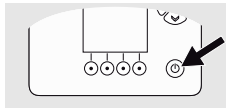

Press the **On/Off** button.

⇒The ventilator starts up and enters standby mode.

### 6.2 Start the Treatment

#### **WARNING!**

#### **Risk of Asphyxia or Personal Injury**

Using incorrect settings may cause personal injury or severe medical conditions, such as hypercarbia, producing arterial acidemia.

The therapy settings shall be based on a physician's prescription. Changes to settings must be made by authorized clinical personnel only.



It is possible to choose how the machine will start and stop. If you want to confirm the starting and stopping or not, see 3.5.5.1 *Device Settings*, page 29

#### **Confirm Start/Stop is set to On**

Make sure that the Vivo 3 is in *Standby* mode.

1 Press and hold the **On/Off** button until the *Starting Treatment* progress bar is filled.

⇒The Vivo 3 now performs a function test indicated by a short beep and then starts the treatment. Check that the self test is performed successfully, this is indicated by:

- A short beep indicating successful alarm signalling
- The alarm LED first lights yellow, then red
- The audio pause LED lights yellow
- In about a second, both LEDs are turned off

If the function test beep absents, take the Vivo 3 out of use and contact your supplier of the Vivo 3 .

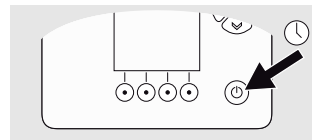

### Confirm Start/Stop is set to Off

- 1 Make sure that the Vivo 3 is in *Standby* mode.
- 2 Press the **On/Off** button.
- 3 The machine performs a function test as described above.

## 6.3 Stop the Treatment

It is possible to choose how the machine will start and stop. If you want to confirm the starting and stopping or not, see 3.5.5.1 *Device Settings*, page 29

### Confirm Start/Stop is set to On

- 1 Press and hold the **On/Off** button until the *Stopping Treatment* progress bar is filled.  
⇒ A request for a complementary action is now displayed for stopping the treatment. If no complementary action is taken within 6 seconds, the Vivo 3 reverts to normal operation.

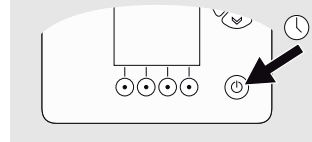

- 2 Do one of the following:
  - Press the **Mute Alarm** button (a). (Always available.)
  - Press **Ramp** (b) for a ramped stop. (Available if a *Ramp Down* time has been specified.)

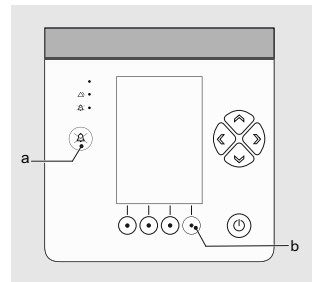

### Confirm Start/Stop is set to Off

- 1 Press the **On/Off** button.
- 2 Press **Ramp** (b) for a ramped stop. (Available if a *Ramp Down* time has been specified.)

## 6.4 Switch Off the Vivo 3

### Confirm Start/Stop is set to On

1 Make sure that the treatment is stopped and the Vivo 3 is in *Standby* mode.

2 Press the **On/Off** button.

⇒When the message “Do you want to turn off the ventilator?” is displayed, confirm by pressing the **Mute Alarm** button within 6 seconds. Otherwise, the Vivo 3 will revert to standby mode.

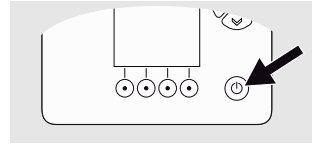

3 Press the **Mute Alarm** button.

⇒ The Vivo 3 is now turned off.

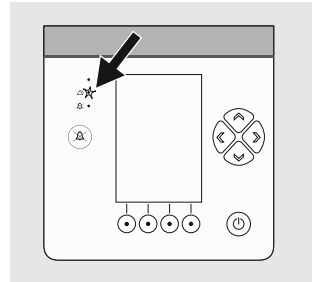

### Confirm Start/Stop is set to Off

1 Make sure that the Vivo 3 is in *Standby* mode.

2 Press and hold the **On/Off** button.

⇒ The Vivo 3 is now turned off.

## 6.5 Monitor Treatment

1 Press the **Monitor** navigation button.

⇒The Monitor page is now displayed. See 3.5.2 *The Monitor Page*, page 27

## 6.5.1 Treatment Values Monitored by the Vivo 3

- **Flow**

Flow is the constant flow for HFNT. It is the only monitored value when HFNT is active.

- **Ppeak**

$P_{peak}$  (*Peak pressure*) is the highest pressure that is recorded during the latest inspiratory phase.

- **EPAP**

EPAP (*Expiratory Positive Airway Pressure*) is the lowest pressure that is recorded during the latest expiratory phase.

- **Leakage**

Leakage is the average calculated leak (l/min) over the last breath, with a breath by breath update.

- **MVe**

Mve (*Minute Volume, expiratory*) is calculated as the Tidal Volume multiplied with the Total Breath Rate.

- **Vte**

Vte (*Tidal volume, expiratory*) is the expired tidal volume for each breath.

- **SpO2**

SpO<sub>2</sub> (*Saturation of Peripheral Oxygen*) displays the patient's oxygen saturation, as measured by the SpO<sub>2</sub> module.

This value is only displayed if the SpO<sub>2</sub> module is connected.

Displayed ranges: According to the manufacturer's specifications.

- **Pulse Rate**

Pulse Rate displays the patient's pulse rate as measured by the SpO<sub>2</sub> module.

This value is only displayed if the SpO<sub>2</sub> module is connected.

Displayed ranges: According to the manufacturer's specifications.

## 6.6 Using Accessories

This section describes how to use accessories provided by Breas Medical AB.

### 6.6.1 Using the Attachable Humidifier



#### **WARNING!**

Read the section 2.7 *Humidification and Heating — Warnings and Precautions*, page 17 before using the Vivo 3 with the attachable humidifier.



The humidifier is for single patient use only.



#### **NOTE**

The ventilator can also be used with active stand-alone and passive humidifiers

## About the Attachable Humidifier

The humidifier is intended to humidify the patient air. It is intended for non-invasive use only.

The humidifier is intended for stationary use and requires a connection to the Mains power supply to work. During mobile use of the Vivo 3, remove the humidifier water chamber and insert the air bypass unit.

### Using the Attachable Humidifier for the First Time — Overview

- 1 Take out the air bypass unit by pressing the locking latch (a) and then pulling it out.
- 2 Fill the humidifier with water.
- 3 Insert the humidifier.

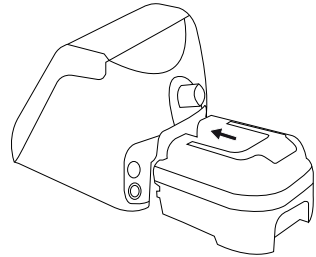
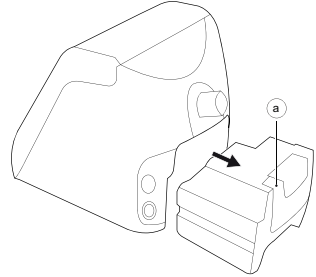

### Detach the Humidifier from the Vivo 3

- 1 If any treatment is running, stop it.
- 2 Push down the locking latch (a) and then pull the humidifier out.
- 3 If you will use the Vivo 3 without the humidifier, install the air bypass unit in place of the humidifier.

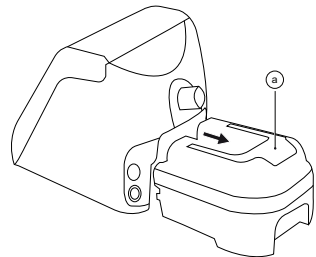

## Fill the Humidifier

### Duration of operation between humidifier refills

Humidifier level (5): 12 hours. At lower settings, the duration will be longer.

### CAUTION!

- The water chamber must be detached from the Vivo 3 when filling water into the water chamber.
- Use only distilled or sterilized water or boiled, chilled tap water in the humidifier water chamber. This is to reduce bacteria and mineral deposits. Do not add any substances to the water, as this can have adverse effect.
- Do not fill the water chamber with hot water.
- Do not overfill the water chamber. The water chamber has a capacity of 350 ml and the maximum filling level is indicated on the chamber.
- After using the ventilator, wait one minute before you open the water chamber since it can get hot under certain conditions (for example if the humidifier runs out of water).



- 1 Detach the water chamber, see above.
- 2 Inspect the water chamber for damages, dirt or deposits. Clean if required, see 8.1.2 *Clean the Humidifier Water Chamber*, page 72. If the water chamber is damaged, replace it before use.
- 3 Make sure the water meets the quality requirements. It shall be either:
  - Distilled
  - Sterilized
  - Boiled and chilled tap water.

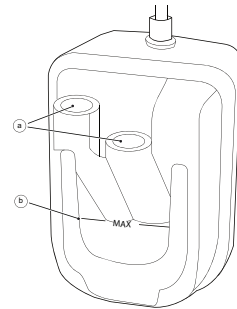

- 4 Hold the humidifier with the air path openings (a) up and fill water into either of the air path openings. Make sure not to overfill (b).
- 5 If the outside of the humidifier is wet, dry it with a lint free cloth before attaching it to the Vivo 3.

## Attach the Humidifier to the Vivo 3

- 1 If any treatment is running, stop it.
- 2 If the air path bypass unit is installed to the Vivo 3, remove it by pressing the locking latch (a) and then pulling it out.
- 3 Make sure the humidifier is correctly filled and push it into the Vivo 3 so the locking latch is engaged.  
⇒ A click indicates that the humidifier is correctly installed.

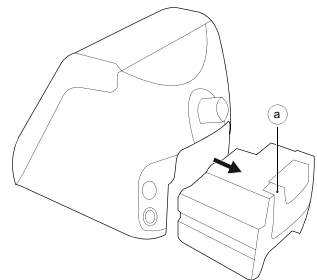



## Activate the Humidifier

- 1 Press the **Setup** button twice.  
⇒The second setup page is now displayed, with humidifier settings.
- 2 Press the **Up arrow** button until the setting **Humidifier** is selected.
- 3 Press the **Right arrow** button to turn the humidifier on.  
⇒The value is shifted to On and the humidifier symbol is lit on the display.  
⇒The setting for Humidifier Level is displayed.
- 4 Press the **Down arrow** to select the **Humidifier Level** setting.
- 5 Press the **Left arrow** button to decrease the humidification or the **Right arrow** button to increase the humidification.

## When not Using the Humidifier

- 1 Take out the humidifier by pushing down the locking latch (a) and then pull the humidifier out.
- 2 Empty the humidifier of water.
- 3 Insert the air path bypass unit.

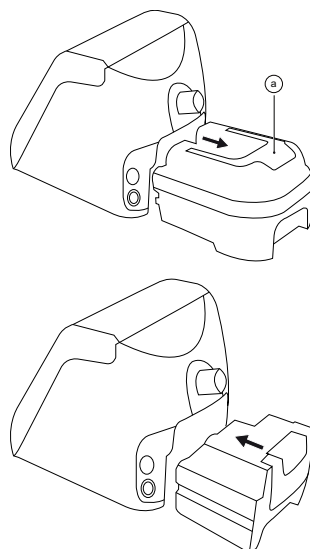

### 6.6.2 Using the Heated Circuit



#### WARNING!

Read section 2.7 *Humidification and Heating — Warnings and Precautions*, page 17 before using the Vivo 3 with the heated circuit.



#### NOTE

The heated circuit requires connection to the Mains power supply to work.



Information about safety, warnings, product description, installation, usage, cleaning, maintenance and technical specifications can be found in the user instruction for the heated circuit.



For information about connecting a patient circuit with heated circuit, see 5.4 *Connecting the Patient Circuit*, page 38.

### Activate the heated circuit

- 1 Press the **Setup** button twice.  
⇒The second setup page is now displayed, with heated circuit settings.
- 2 Press the **Up arrow** button until the setting **Heated Circuit** is selected.
- 3 Press the **Right arrow** button to turn the heated circuit on.  
⇒The value is shifted to On and the heated circuit symbol is lit on the display.  
⇒The setting for Heated Circuit Level is displayed.
- 4 Press the **Down arrow** to select the **Heated Circuit Level** setting.
- 5 Press the **Left arrow** button to decrease the heating or the **Right arrow** button to increase the heating.

### 6.6.3 Using the SpO<sub>2</sub> Module

The SpO<sub>2</sub> module (006369) enables connection to an SpO<sub>2</sub> sensor for measuring of functional oxygen saturation of arterial haemoglobin (SpO<sub>2</sub>) and pulse rate. The SpO<sub>2</sub> measurements will be stored in the data memory which can be downloaded to a PC and viewed in the PC software.

- 1 Connect either of the the SpO<sub>2</sub> adapter cable (007079) or the accessory box (007000) to the communication port (1).
- 2 Connect the SpO<sub>2</sub> module to the adapter cable or accessory box.
- 3 Connect the SpO<sub>2</sub> sensor to the SpO<sub>2</sub> module.

When starting the ventilator, check that the SpO<sub>2</sub> symbol on the screen is lit.

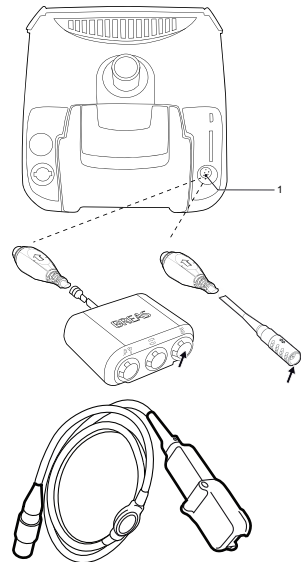

## Technical Data

SpO <sub>2</sub> measurement	Range: 70 to 100% Tolerance: $\pm 3$ digits. No motion and flex sensor.
Pulse rate measurement	Range: 25 to 240 bpm. Tolerance: $\pm 3$ digits. No motion and flex sensor.
SPO <sub>2</sub> sensor light characteristics	Peak Wavelength (red): 660 nm Peak Wavelength (infrared): 905 nm Maximum Optical Output Power: $\leq 15$ mW For more information regarding the oxygen probe's characteristics and usage, please refer to the respective probe manual.



Information about safety, warnings, product description, installation, usage, cleaning, maintenance and technical specifications can be found in the user instruction for the SpO<sub>2</sub> module. (006357).



### CAUTION!

- When using the Vivo 3 with the SpO<sub>2</sub> module and sensor, the Vivo 3 displays functional oxygen saturation measured by the sensor.
- Environmental factors may influence the function or accuracy of the pulse oximeter, such as ambient light, physical movement, diagnostic testing, low perfusion, electromagnetic interference, dysfunctional haemoglobin, presence of certain dyes and inappropriate positioning of the pulse oximeter probe.
- A functional test cannot be used to assess the accuracy of a pulse oximeter probe or a pulse oximeter.

### 6.6.4

#### Oxygen Supply After the Patient Air Outlet



#### WARNING!

Refer to 2.9 *Oxygen Usage — Warning and Precautions*, page 20 when using oxygen with the device

Supplemental oxygen may be added anywhere in the patient circuit provided that a compatible pressure valve such as the Philips Respironics Pressure valve is placed in line between the device and the oxygen source.

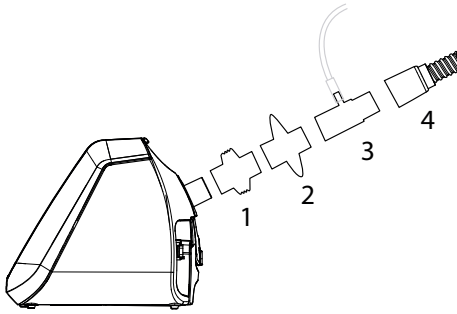

1. Philips Respironics pressure valve, part number 302418
2. Low resistance bacterial filter, part number 007963
3. Philips Respironics O<sub>2</sub> enrichment port, part number 312710
4. Patient circuit

### 6.6.5 Using the Nurse Call Connection

The Vivo 3 can be connected to a nurse call system through a port on the accessory box. When connected, alarms from the Vivo 3 will be forwarded to the nurse call system.

- 1 Connect the Accessory box to the Communication port at the back of the Vivo 3.
- 2 Connect the nurse call cable to the Nurse call/Remote alarm port on the accessory box.

⇒The Nurse call symbol is now lit on the display.

- 3 Trigger an alarm on the Vivo 3 and check that it activates the nurse call system. For detailed information about triggering alarms, see .

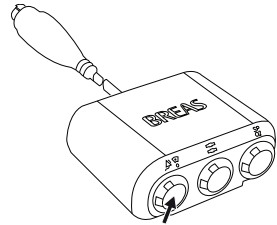

### 6.6.6 Using the Remote Alarm Unit



Information about safety, warnings, product description, installation, usage, cleaning, maintenance and technical specifications can be found in the user instruction for Remote Alarm.

The Remote Alarm enables care providers and clinical personnel to monitor the Vivo 3 alarms remotely. The Remote Alarm forwards alarms from the Vivo 3.

- 1 Connect the Accessory box to the Communication port at the back of the Vivo 3.
- 2 Connect the remote alarm cable to the Nurse call/Remote alarm port on the accessory box.
- 3 Start the remote alarm unit.
- 4 Trigger an alarm on the Vivo 3 and check that it activates the remote alarm system.

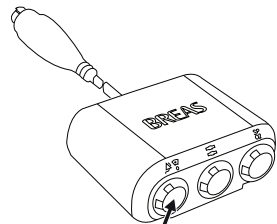

### 6.6.7 Using the Protective Cover

The protective cover is intended for mobile use of the Vivo 3 in hospitals, institutions and home care environments. It can be used while the Vivo 3 is operating, for example mounted on a wheelchair, in a personal vehicle, or carried by hand.

The protective cover protects the Vivo 3 from environmental impact such as shock, water spill, sunlight, dust and dirt, under normal handling.

#### CAUTION!

The Vivo 3 is not to be used with a protective cover while positioned in a warm place such as direct sunlight or close to a radiator.

The protective cover does not protect the Vivo 3 from rain or snowfall.

- The protective cover can be used together with external power supply units.
- The protective cover cannot be used together with the attachable humidifier. When using the protective cover, the air path bypass unit shall be installed in place of the attachable humidifier.

### 6.6.8 Using the Lightweight Mobility Bag

The lightweight Mobility Bag is intended for mobile use of the Vivo 3 in hospitals, institutions and home care environments. It can be used while the ventilator is operating, for example mounted on a wheelchair, in a personal vehicle, or carried by hand.

The lightweight Mobility Bag protects the ventilator from, water spill, sunlight, dust and dirt, under normal handling.

The lightweight mobility bag cannot be used together with the attachable humidifier. When using the lightweight mobility bag, the air path bypass unit shall be installed in place of the attachable humidifier.

**It does not protect against environmental impact such as shock, from rain or snowfall.**

### 6.6.9 Using the Y-Cable

The Y-cable is used for connecting the Vivo 3 to both mains and external DC at the same time. see 5.3 *Connecting the Vivo 3 to Power Supply*, page 37. When both power sources are available, the mains will be used.

### 6.6.10 Using the Vivo 3 with the Trolley

#### Intended Use

The intended use of the trolley system is to allow patient mobility while receiving ventilator treatment. The trolley shall only be used in indoor, hospital environment. The trolley system consists of a trolley base and a mounting bracket.

This section describes how to use the Vivo 3 and a trolley with mounting bracket.



Mount and dismount the Vivo 3 as shown in the picture:

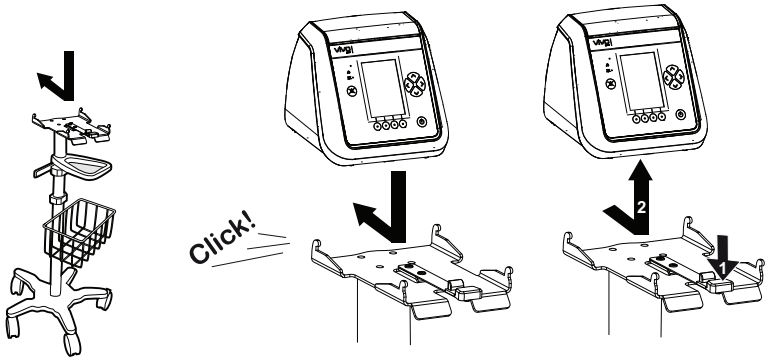

The bottom plate is mounted to the trolley using four screws.

Before mounting the bottom plate, the attachment must be dismantled:

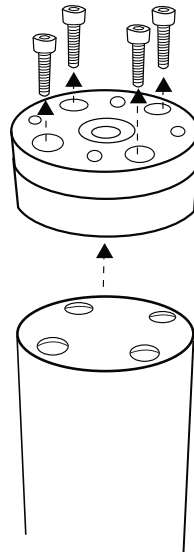

Be careful when handling the trolley with the ventilator mounted, in order to avoid any risk of the trolley falling. The trolley can be tipped 10° and return to vertical position, when loaded in accordance with the weight specifications below.

### **WARNING!**

The maximum total weight of the trolley and added accessories is 37 kg (82 lbs). (Trolley base weight = 12 kg (26 lbs), maximum externally added load = 25 kg (55 lbs).)

- The maximum load of the trolley basket is 0.9 kg (2 lbs).
- The maximum load of the trolley rail is 9 kg (20 lbs).

No maintenance is required.

## 6.7 Basic Troubleshooting

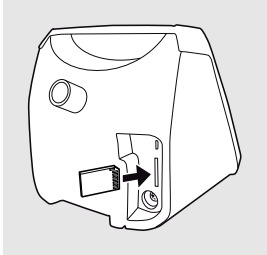
Problem	Action
The ventilator doesn't start.	Check the connection of the power cord between the ventilator and the power outlet.
The ventilator starts, but the patient circuit doesn't deliver any air.	Ensure that both ends of the patient circuit are correctly connected. Straighten the patient circuit or replace it.
The humidifier doesn't work properly.	If the humidifier is incorrectly assembled, disassemble it and then assemble it correctly. If the air is dry despite using the humidifier, increase the level of humidification. If the humidifier doesn't deliver any heat, check that the Vivo 3 is powered from the AC power supply; the humidifier doesn't work on battery.
<p>SD card failure. Indicated by a display message and a crossed out SD card symbol on the display.</p> 	<p>If the SD card is malfunctioning, treatment logs are not written to the card. Alternative 1: Remove and reinsert the SD card.</p>  <p>Alternative 2: Switch the Vivo 3 off and back on again. For detailed instructions, see 6.4 <i>Switch Off the Vivo 3</i>, page 43 and 6.1 <i>Switch On the Vivo 3</i>, page 41. If the problem persists after performing the actions, replace the SD card.</p>

## Alarms

### WARNING!

#### Risk of Unnoticed Critical Conditions

- All the physiological alarms of the Vivo 3 must be set at safe levels that will effectively warn the user of any risk.  
The alarm levels should be assessed considering the patient's treatment settings.
- Any change of treatment settings or change of components in the ventilation system may require readjustment of the alarm levels.
- The alarm sound level should be set to a clearly audible level. Setting the alarm sound level below that of the ambient sound level can impede recognition of alarm conditions.



#### Distributed Alarm System

Distributed alarm system for the ventilator:

- The cable connected remote alarm unit provided by Breas Medical AB

#### Alarm Function During Power Failure

At power failure, the following will happen:

1. When the mains power is broken, the internal battery takes over the power supply and the following message is displayed: Switched to Internal Battery.
2. When 20 minutes ( $\pm 5$  minutes) of the battery charge remains, the following alarm (Medium) is displayed: Last Power Source Low Capacity. An audio signal is heard.
3. When 5 – 7 minutes of the battery charge remains, the following alarm (High) is displayed: Critical Low Last Power Source. An audio signal is heard.
4. When 0 minutes of the battery charge remains, the following message is displayed: The internal battery is completely discharged. Connect mains or DC to charge.
5. An alarm is triggered, and the Vivo 3 is powered off.  
The alarm settings are maintained during power failure.

### 7.1 Operator's Position

The alarm priority indications are designed to be recognized from a distance of 4 meters and by an angle of 50 ° from the normal of the Vivo 3 display.



## 7.1.1 Checking the Operator's Position

The patient shall not be connected during these checks.

- 1 With treatment started on the Vivo 3, disconnect the patient circuit to activate an alarm.
- 2 From the operator's position, make sure that the audible alarm signal is heard and that it is possible to recognize the alarm priority level by either of the visual signals (flashing LED lights and display message on the screen). The sound pressure level range is 55-80 dBA for high and medium priority alarm signals.

For detailed information, see 7.2.1 *Identify an Alarm Condition*, page 55.

- 3 If the test fails, consider the following actions:
  - Find a better position for the operator.
  - Adjust the alarm sound level, see 7.2.5 *Adjust the Alarm Sound Level*, page 58.

## 7.2 Handle Alarms

### 7.2.1 Identify an Alarm Condition

If an alarm condition is detected, the Vivo 3 main unit and the remote alarm unit (if connected) will alarm without delay. The alarms will remain active until the alarm condition is resolved.

Active alarms are indicated by:

- Audible signal, see page 55.
- Alarm message on the screen, see page 56.
- The alarm LED, see page 56.

#### Alarm Audio signal

- **High priority alarms**  
3 short signals followed by 2 more after 0.5 s.  
The signal sequence repeats every 3rd second.
- **Medium priority alarms**  
3 signals. The signal sequence repeats every 6th second.



For information about adjusting the alarm sound level, see 7.2.5 *Adjust the Alarm Sound Level*, page 58.

#### Information Message Audio Signal

Short signal every 5 seconds



#### Alarm Sound Pressure Level

The alarm sound pressure level is adjustable within 55–80 dBA.

## Alarm Message on the Screen

The name of the active alarm is displayed on the screen.

- **High priority alarms**  
Red highlight color.
- **Medium priority alarms**  
Yellow highlight color.



For detailed information about specific alarms, see 7.3 *Physiological Alarms*, page 58 and 7.4 *Technical Alarms*, page 66.

### Display of Multiple Alarms

If several alarms are active, active high priority alarms have precedence over medium priority alarms: All high priority alarm conditions must be resolved before any medium alarms are displayed.

If several alarms of the same priority are active at the same time, the alarm descriptions are looped in the display.

A “>>” symbol indicates that more alarms are to be displayed in the loop.

### Alarm LED signal

- **High priority alarms**  
Red light, flashing quickly (0.5 s. interval).
- **Medium priority alarms**  
Yellow light, flashing slowly (2 s. interval).

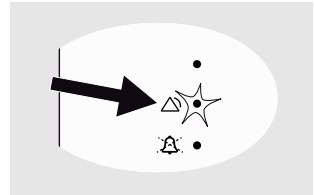

## 7.2.2 Pause the Alarm Sound

The audible signal can be paused for 60 seconds by pressing the Audio Pause button. Pressing the button again reactivates the sound.

If a new alarm condition occurs during the audio pause period, the audible signal will be reactivated.

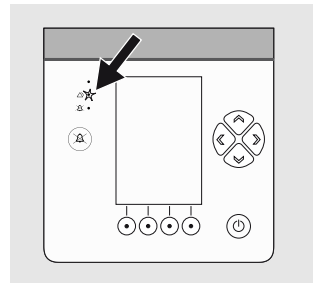

## 7.2.3 Reset an Alarm

To reset an alarm, correct the cause of the alarm condition.

⇒ Once the cause is corrected, the alarm disappears from the display.

### WARNING!

If an alarm condition cannot be corrected, take the Vivo 3 out of use and contact your supplier of the Vivo 3.



## 7.2.4 View Historical Alarms

To view historical alarms, press the Alarm button until Alarm/Event history is shown.



## 7.2.5 Adjust the Alarm Sound Level

Alarm Sound Level is found in the Alarm Settings.

1 Press the Alarm navigation button until the Alarm settings page with Alarm Sound Level is shown.

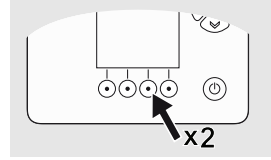

2 Press the Down or Up arrow button to select the Alarm Sound Level setting.

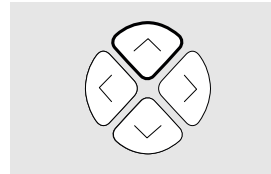

3 Press the Left or Right arrow buttons to adjust the sound level.

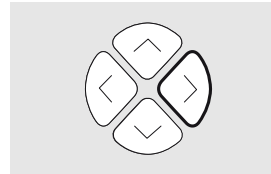

4 Press the Up arrow button to finish the adjustment by deselecting the setting.

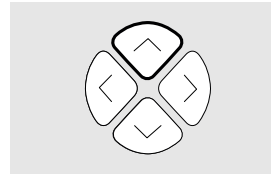

5 When finished with the sound level adjustment, check that the alarm can be received at the operator's position, see 7.1 *Operator's Position*, page 54.

## 7.3 Physiological Alarms

For complete alarm information including setting ranges, see the Clinician's manual.

### 7.3.1 High Pressure Alarm

Property	Description
Alarm text	<b>High Pressure</b>
Priority	High
Alarm condition	A High Pressure alarm will be given when the patient pressure reaches the set High Pressure alarm limit for three consecutive breaths.
Possible cause	<ul style="list-style-type: none"><li>• Mismatch between pressure setting and alarm setting.</li><li>• Coughing during inspiration.</li><li>• Changes in airway resistance and or compliance.</li></ul>
Reset criteria	A full breath is performed with maximum pressure below the alarm limit.
Ventilator action	The Vivo 3 will continue treatment according to the current settings. The actual breath is however terminated if the High Pressure alarm limit is reached.
Setting Display	The High Pressure alarm setting is displayed by a red line in the pressure bar graph. 

### 7.3.2 Low Pressure Alarm

Property	Description
Alarm text	<b>Low Pressure</b>
Priority	High
Alarm condition	A Low Pressure alarm will be given when the Vivo 3 pressure fails to reach the low pressure alarm limit for 15 seconds.
Possible cause	<ul style="list-style-type: none"><li>• Disconnection of patient circuit.</li><li>• Mismatch between pressure setting and alarm setting.</li><li>• Leakage from the mask or other components of the patient circuit.</li></ul>
Reset criteria	The pressure rises above the alarm limit.
Ventilator action	The Vivo 3 will continue treatment according to the current settings.
Setting display	The Low Pressure alarm setting is displayed by a red line in the pressure bar graph. 

### 7.3.3 High Breath Rate Alarm

Property	Description
Alarm text	<b>High Breath Rate</b>
Priority	Medium
Alarm condition	A High Breath Rate alarm will be given when the alarm limit has been exceeded for 15 seconds.
Possible cause	<ul style="list-style-type: none"><li>• Mismatch between the Breath Rate setting and the alarm setting.</li><li>• Increased Breath Rate.</li><li>• Too sensitive setting of the inspiratory trigger setting.</li></ul>
Reset criteria	The breath rate goes below the alarm limit.
Ventilator action	The Vivo 3 will continue treatment according to the current settings.

### 7.3.4 Low Breath Rate Alarm

Property	Description
Alarm text	<b>Low Breath Rate</b>
Priority	High
Alarm condition	A Low Breath Rate alarm will be given when the delivered total breath rate is below the alarm limit for 15 seconds.
Possible cause	<ul style="list-style-type: none"><li>• Mismatch between the Breath Rate setting and the alarm setting.</li><li>• The patient cannot trigger breaths because the inspiratory trigger setting is too high.</li><li>• Decrease in the patient's spontaneous breathing.</li><li>• Circuit disconnection.</li></ul>
Reset criteria	The breath rate goes above the alarm limit.
Ventilator action	The Vivo 3 will continue treatment according to the current settings.

### 7.3.5 High Minute Volume Alarm

Property	Description
Alarm text	<b>High MV</b>
Priority	Medium
Alarm condition	A High Minute Volume alarm will be given when the minute volume is above the set alarm limit for 15 seconds.
Possible cause	<ul style="list-style-type: none"><li>• Disconnection of patient circuit.</li><li>• Mismatch between pressure setting and alarm setting.</li><li>• Leakage from the mask or other components of the patient circuit.</li><li>• Increased breath rate.</li></ul>
Reset criteria	The minute volume goes below the alarm limit.
Ventilator action	The Vivo 3 will continue treatment according to the current settings.

### 7.3.6 Low Minute Volume Alarm

Property	Description
Alarm text	<b>Low MV</b>
Priority	High
Alarm condition	A Low Minute Volume alarm will be given when the minute volume is below the set alarm limit for 15 1 seconds.
Possible cause	<ul style="list-style-type: none"><li>• Disconnection of patient circuit.</li><li>• Mismatch between pressure setting and alarm setting.</li><li>• Leakage from the mask or other components of the patient circuit.</li><li>• Decreased breath rate.</li></ul>
Reset criteria	The minute volume goes above the alarm limit.
Ventilator action	The Vivo 3 will continue treatment according to the current settings.

### 7.3.7 Rebreathing Alarm

Property	Description
Alarm text	<b>Rebreathing</b>
Priority	High
Alarm condition	A Rebreathing alarm will be given if the intentional leakage is too low for more than 15 seconds.
Possible cause	<ul style="list-style-type: none"><li>• Obstructed or occluded patient circuit.</li><li>• Incorrect patient circuit.</li></ul>
Reset criteria	The leakage is back within limits.
Ventilator action	The Vivo 3 will continue treatment according to the current settings.

### 7.3.8 Apnea Alarm

The Vivo 3 is not intended for use as an Apnea monitor.

Property	Description
Alarm text	<b>Apnea</b>
Priority	High
Alarm condition	An Apnea alarm will be given when no patient-triggered breath is detected for the set period of time.
Possible cause	<ul style="list-style-type: none"><li>• Patient stopped breathing.</li><li>• Patient decreases spontaneous breathing.</li><li>• Circuit disconnection.</li><li>• Inspiratory Trigger is set too high.</li></ul>
Reset criteria	Inspiratory effort detected by the Vivo 3.
Ventilator action	The Vivo 3 will continue treatment according to the current settings.

### 7.3.9 Disconnection Alarm

#### CAUTION!

No single alarm can reliably detect all disconnections due to the number of possible combinations of therapy settings, circuit configurations and patient interfaces. To verify that patient disconnection can be detected, including if the patient interface becomes accidentally detached from the patient, it is advised to test the functionality of the Disconnection Alarm upfront with the complete set-up as used during treatment, including items such as filters, circuit, connectors, interface (mask, cannula etc.)





Property	Description
Alarm text	<b>Disconnection</b>
Priority	High
Alarm condition	A Disconnection alarm will be given when the measured flow exceeds the expected leakage flow at the set Pressure for 15 seconds.
Possible cause	<ul style="list-style-type: none"> <li>• Too high leakage in the patient circuit.</li> <li>• The patient has removed the mask.</li> <li>• Circuit disconnection.</li> </ul>
Reset criteria	The leakage is back within limits.
Ventilator action	The Vivo 3 will continue treatment according to the current settings

### 7.3.10 High EPAP Alarm

Property	Description
Alarm text	<b>High EPAP</b>
Priority	Medium
Alarm condition	A High EPAP alarm will be given when EPAP has gone 30% above the set value for 3 breaths.
Possible cause	<ul style="list-style-type: none"> <li>• Blocked leakage port.</li> <li>• Too short expiratory time.</li> <li>• Changes in airway resistance and or compliance.</li> </ul>
Reset criteria	EPAP has gone below the alarm limit (lower than 30% above the set value).
Ventilator action	The Vivo 3 will continue treatment according to the current settings.

### 7.3.11 Low EPAP Alarm

Property	Description
Alarm text	<b>Low EPAP</b>
Priority	Medium
Alarm condition	A Low EPAP alarm will be given when EPAP has gone 30% below the set value for 3 breaths.
Possible cause	<ul style="list-style-type: none"> <li>• Excessive leakage.</li> </ul>
Reset criteria	EPAP has gone above the alarm limit (higher than 30% below the set value).
Ventilator action	The Vivo 3 will continue treatment according to the current settings.

### 7.3.12 High SpO<sub>2</sub> Alarm

Property	Description
Alarm text	<b>High SpO<sub>2</sub></b>
Priority	Medium
Alarm condition	A High SpO <sub>2</sub> alarm will be given when the measured SpO <sub>2</sub> exceeds the alarm limit for 30 seconds.
Possible cause	
Reset criteria	The SpO <sub>2</sub> value goes back below the alarm limit.
Ventilator action	The Vivo 3 will continue treatment according to the current settings.

This alarm requires a connected SpO<sub>2</sub> sensor.

### 7.3.13 Low SpO<sub>2</sub> Alarm

Property	Description
Alarm text	<b>Low SpO<sub>2</sub></b>
Priority	High
Definition	A Low SpO <sub>2</sub> alarm will be given when the measured SpO <sub>2</sub> is below the alarm limit for 30 seconds.
Possible cause	<ul style="list-style-type: none"><li>Delivered tidal volumes are too small.</li></ul>
Ventilator action	The ventilator will continue treatment with the same settings.

This alarm requires a connected SpO<sub>2</sub> sensor.

### 7.3.14 High Pulse Rate Alarm

Property	Description
Alarm text	<b>High Pulse Rate</b>
Priority	Medium
Alarm condition	A High Pulse Rate alarm will be given when the measured pulse rate exceeds the alarm limit for 15 seconds.
Possible cause	<ul style="list-style-type: none"><li>Insufficient ventilatory support.</li><li>The EPAP value is set too high.</li><li>Bad positioning of the finger probe.</li></ul>
Reset criteria	The pulse rate goes back below the alarm limit.
Ventilator action	The Vivo 3 will continue treatment according to the current settings.

This alarm requires a connected SpO<sub>2</sub> sensor.

### 7.3.15 Low Pulse Rate Alarm

Property	Description
Alarm text	<b>Low Pulse Rate</b>
Priority	High
Alarm condition	A low pulse rate alarm will be given when the measured pulse rate goes below the alarm limit for 15 seconds.
Possible cause	<ul style="list-style-type: none"><li>• Bad positioning of the finger probe.</li><li>• Insufficient ventilatory support.</li></ul>
Reset criteria	The pulse rate goes back above the alarm limit.
Ventilator action	The Vivo 3 will continue treatment according to the current settings.

This alarm requires a connected SpO<sub>2</sub> sensor.

### 7.3.16 Circuit Disconnection Alarm

Property	Description
Alarm text	<b>Circuit Disconnection</b>
Priority	High
Alarm condition	Only available when HFNT is active. The alarm will be given if the device detects that the patient circuit is disconnected from the device. It will not detect if the patient is connected or not, only if the cannula and/or tube is connected to the device.
Possible cause	The circuit is disconnected.
Reset criteria	The device detects that the tube and/or cannula is connected again.
Ventilator action	The Vivo 3 will continue treatment according to the current settings.

### 7.3.17 Blocked Circuit Alarm

Property	Description
Alarm text	<b>Blocked Circuit</b>
Priority	High
Alarm condition	Only available when HFNT is active. The alarm will be given if the device detects that the patient circuit is blocked and no air can be delivered.
Possible cause	The circuit is blocked.
Reset criteria	The device detects that the circuit is not blocked anymore.
Ventilator action	The Vivo 3 will continue treatment according to the current settings.

## 7.4 Technical Alarms

### 7.4.1 High Pressure Limitation Alarm

Property	Description
Alarm text	<b>High Pressure Limitation</b>
Priority	High
Alarm condition	The High Pressure Limitation alarm is given if the high pressure alarm limitation limit (60 cmH <sub>2</sub> O) is reached.
Possible cause	<ul style="list-style-type: none"><li>• Mismatch between pressure setting and alarm setting.</li><li>• Coughing during inspiration.</li><li>• Changes in airway resistance and or compliance.</li></ul>
Reset criteria	A full breath with pressure below the set alarm limit.
Ventilator action	The current breath is terminated and then the Vivo 3 will continue treatment according to the current settings.

### 7.4.2 Power Fail Alarm

Property	Description
Alarm text	The display is turned off. The Power Fail alarm is indicated by the alarm LED and the audible signal only.
Priority	High The display is turned off. The Power Fail alarm is indicated by the alarm LED and the audible signal only.
Alarm condition	The Power Fail alarm is given if the last power source fails to provide enough power for running the ventilator.
Possible cause	The last available power source cannot deliver power to the ventilator. Battery discharged or battery failure.
Reset criteria	External power supply connected to ventilator.
Ventilator action	The Vivo 3 stops the treatment, turns off the display and gives the Power Fail alarm for at least 2 minutes. If power is restored within the alarm time, the ventilator will automatically resume treatment with current settings. When powered up again, the power failure will be logged.

### 7.4.3 SpO<sub>2</sub> Sensor Failure / Disconnected Alarm

This alarm requires a connected SpO<sub>2</sub> sensor.

Property	Description
Alarm text	<b>SpO2 Disconnected</b>
Priority	Medium
Alarm condition	An SpO <sub>2</sub> Sensor Failure/Disconnection alarm will be given if one of the conditions below appears: <ul style="list-style-type: none"><li>• An error signal is received from the sensor</li><li>• No signal at all from the sensor is received within 2 seconds.</li></ul>
Possible cause	Faulty or disconnected sensor.
Reset criteria	Normal communication with the sensor is re-established. An information message remains until acknowledged by the user.
Ventilator action	The Vivo 3 will continue treatment according to the current settings.

### 7.4.4 SpO<sub>2</sub> Artifact

This alarm requires a connected SpO<sub>2</sub> sensor.

Property	Description
Alarm text	<b>Poor SpO2 Signal</b>
Priority	Medium
Alarm condition	A poor SpO <sub>2</sub> Signal alarm will be given if perfusion is too low or artifacts are detected by the sensor.
Possible cause	Check the sensor and its placement on the patient.
Reset criteria	An OK signal is received from the sensor or the sensor is disconnected. An information message remains until acknowledged by the user.
Ventilator action	The Vivo 3 will continue treatment according to the current settings.

### 7.4.5 Ambient Pressure Compensation Lost Alarm

Property	Description
Alarm text	<b>Pressure Comp Lost</b>
Priority	Medium
Alarm condition	An Ambient Pressure Compensation Lost alarm will be given when the automatic ambient pressure compensation functionality is out of order.
Ventilator action	The Vivo 3 will continue treatment according to the current settings. Normal atmospheric pressure at sea level will be used as approximation for the temporary ambient pressure compensation. If used at other altitude, delivered and measured pressures may deviate.
Reset	Reset of ventilator.

### 7.4.6 Low Battery Alarm

Property	Description
Alarm text	<b>Low Battery. Connect to Mains.</b>
Priority	Medium
Alarm condition	This alarm will be given when the last battery source (internal battery) has 15 minutes of operating time left with current settings.
Ventilator action	The Vivo 3 will continue treatment according to the current settings.
Reset Criteria	Connection of another power source within 15 minutes or the treatment will shut down.

### 7.4.7 Critically Low Battery Alarm

Property	Description
Alarm text	<b>Critically Low Battery. Connect to Mains</b>
Priority	High
Alarm condition	This alarm will be given when the last battery source (internal battery) has 5 minutes of operating time left with current settings.
Ventilator action	The Vivo 3 will continue treatment according to the current settings.
Reset Criteria	Connection of another power source within 5 minutes or the treatment will shut down.

## 7.4.8 High Patient Air Temp. (High Patient Air Temperature)

Property	Description
Alarm text	<b>High Patient Air Temp</b>
Priority	High
Alarm condition	A High Patient Air Temperature alarm will be given when the patient air temperature exceeds 43°C (109.4°F). If having a patient circuit with an active heated circuit, the patient air temperature is measured by the circuit's temperature sensor. Otherwise, the temperature is measured by the flow measurement sensor inside the Vivo 3.
Possible cause	<ul style="list-style-type: none"><li>Blocked air inlets.</li><li>Too high ambient temperature.</li></ul>
Ventilator action	The Vivo 3 will continue treatment. If a heated circuit or attachable humidifier is used, these will be turned off.
Reset criteria	The temperature goes below the limit again.

## 7.4.9 Flow Sensor Failure

Property	Description
Alarm text	<b>Flow Sensor Failure</b>
Priority	Medium
Alarm condition	No data or erroneous data from the flow sensor
Possible cause	
Reset criteria	Correct data from the sensor is received again. An information message remains until acknowledged by the user.
Ventilator action	The Vivo 3 will continue treatment but with the following limitations: <ul style="list-style-type: none"><li>Monitoring of leakage is disabled.</li><li>Volume measurements are disabled.</li><li>The patient cannot trigger breaths (applies to assisted modes)</li></ul> An information message about the limitations is displayed on the screen.

### 7.4.10

#### Internal Function Failure

Property	Description
Alarm text	<b>Int. Function Failure</b>
Priority	High
Alarm condition	Failure of internal function that prevents treatment or normal operation of the ventilator. The error code that follows the alarm text indicates the kind of function failure.
Reset criteria	Correct function is restored.
Ventilator action	The ventilator will stop the treatment.
Action to take	Restart the Vivo 3. If the alarm persists or reoccurs: Take a note of the error code and contact your supplier of the Vivo 3.



## 8 Cleaning and Maintenance

This chapter contains instructions for cleaning and maintenance actions that can be carried out by the care provider or by users with physical ability and working knowledge of the system.

### **WARNING!**

#### **Risk of Personal Injury**

- Repairs, upgrades and modifications must be carried out by technicians authorized by Breas Medical AB only and in accordance with instructions from Breas Medical AB
- The Vivo 3 must not be opened, repaired or modified by unauthorized personnel. If subjected to unauthorized operations, Breas Medical AB is no longer responsible for the performance and safety of the device and all warranties will become invalid.

The patient-connected parts and the filters must be cleaned and replaced regularly to ensure correct function of the Vivo 3. All replaced parts must be disposed of in accordance with local environmental regulations regarding the disposal of used equipment and waste.

### 8.1 Cleaning the Vivo 3

#### **WARNING!**

##### **Risk of Electric Shock**

Disconnect the power supply before cleaning the Vivo 3 according to the instructions in this manual.

Do not soak the Vivo 3 or immerse it into any fluids.

#### 8.1.1 Clean the Main Unit Externally

##### **Equipment**

- A lint free cloth.
- A mild soap solution or Ethanol 70%.

- 1 Turn off the Vivo 3 and disconnect the power supply.
- 2 Remove the patient circuit.
- 3 If any cable connected accessories (like the SpO<sub>2</sub> sensor or the accessory box) are used, disconnect them.
- 4 Clean the outside of the Vivo 3 using a lint free cloth moistened with a mild soap solution and / or ethanol 70% for surface disinfection.
- 5 Clean the optional accessories in accordance with their respective user instructions.
- 6 Allow all cleaned parts to air dry.
- 7 Visually inspect the ventilator and accessories that have been cleaned. If the ventilator or any of the accessories are not visually clean and dry, repeat the associated cleaning steps or safely dispose of the device.
- 8 Reconnect the patient circuit and any accessories that was disconnected during the cleaning.

## 8.1.2 Clean the Humidifier Water Chamber

The water chamber shall be cleaned weekly.

### **WARNING!**

#### **Risk of Burns**

After using the ventilator, wait one minute before you open the water chamber since it can get hot under certain conditions (for example if the humidifier runs out of water).



- 1 Open the humidifier by pulling the lid up. Don't detach the silicone airpaths (a). Also, don't dismount the cartridge heater (b).
- 2 Wash the humidifier by hand with mild soap and warm water, or in a dishwasher without dishwashing detergent.
- 3 Allow all cleaned parts to air dry.
- 4 Visually inspect the cleaned parts. If they are not visually clean and dry, repeat the associated cleaning steps or safely dispose of the device.
- 5 After cleaning, ensure that the silicone gasket (c) is positioned correctly: When closing the humidifier; the grooved edge must be positioned downwards.

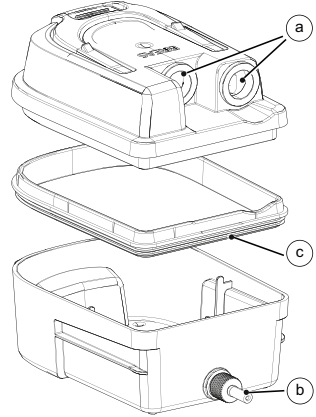

## 8.1.3 Clean the Patient Circuit

### **CAUTION!**

The cleaning and replacement intervals should be established by the care provider, based on the care provider's infection control procedures and the instructions from the patient circuit's manufacturer.

Check the patient circuit regularly for damage. In case of damage, replace the circuit.



The patient circuit should be cleaned and replaced in accordance with the manufacturer's instructions, or by the care provider's instructions if additional cleaning or other replacement intervals are prescribed.

## 8.1.4 Intentionally Deleted

## 8.2 Clean and Replace Patient Air Inlet Filters

The Vivo 3 patient air inlet filters are located inside a magnetic filter holder at the back of the ventilator. The table below describes the filters and their minimum maintenance intervals.

Filter	Maintenance Intervals (minimum)*
Air inlet filter, grey (coarse)	<ul style="list-style-type: none"> <li>• Wash: every week.</li> <li>• Replace: every year or when assigning the Vivo 3 to a new patient.</li> </ul>
Air inlet filter, white (fine)	<ul style="list-style-type: none"> <li>• Replace: every 4th week or when assigning the Vivo 3 to a new patient.</li> </ul>

\* If the Vivo 3 is used in an environment with high grades of pollen or pollutions, shorter intervals might be required.

1 Turn off the Vivo 3 and place it on a clean dust free surface.

2 Pull out the filter holder and remove the filters.

3 If required by the interval or if visibly dirty, wash the grey coarse filter:

1. Wash the filter using warm water and a mild soap.
2. Rinse thoroughly.
3. Dry the filter by first squeezing it in a towel and then letting it dry in the air. Do not wring the filter.
4. Check that the filter is visually clean, completely dry and undamaged before reinstalling it. If not visually clean, repeat the cleaning. If damaged, dispose of the filter safely and replace it with a new one.

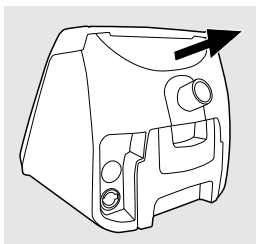

4 When reinstalling the air inlet filters in the filter holder: first install the grey coarse filter, then the white fine filter.

5 Reinstall the filter holder on the Vivo 3.

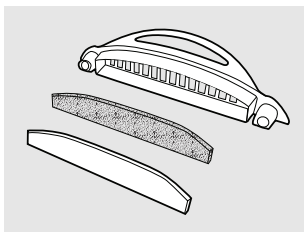

## 8.3 Disposal

The ventilator, any accessories and all replaced parts must be disposed of and recycled in accordance with the local environmental regulations regarding the disposal of used equipment and waste. Contact your service provider for information regarding the disposal procedure.

### NOTE

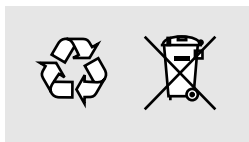

Batteries used with the ventilator shall be recycled in accordance with the local environmental regulations.



## 9 Technical Specifications

### 9.1 Ventilator Size and Weight

Property	Value
Dimensions (WxHxD)	Without humidifier: 166 x 170 x 180 mm With humidifier: 166 x 170 x 235 mm
Weight	1,8 kg

### 9.2 Power Supply

#### Mains Power Supply

Property	Value
Mains Power Supply	100–240 V AC tolerance: +10%/-20%, 50 to 60 Hz, max 1.2 A. The approved AC/DC supply listed in 10 <i>Accessories</i> , page 82 must be used.
Protection against electric shock	Class II ME Equipment

#### External DC Power Supply

The DC/DC power supply unit 006995 must be used between the DC power source and the Vivo 3 to ensure electrical safety.

Property	Value
Input Voltage	12–24 V DC (Isolated by DC/DC power supply unit)
Power	Max 60 W

#### Internal Battery

Property	Value
Battery type	4 cell Li-Ion battery
Nominal Voltage	14.4 V
Capacity	2.1 Ah
Operational time	3 hours
Expected life:	300 charging cycles
Charging time (Empty to full)	< 2 hours.



#### NOTE

When 300 cycles have been exceeded, a notification message is displayed.

## 9.3 Operating Conditions

Environmental Condition	Specification
<b>Normal Operation Temperature</b>	+5°C to +40°C (Humidifier: +15°C to +35°C)
	<ul style="list-style-type: none"><li>• Be careful not to position the Vivo 3 in an extra warm place, such as in direct sunlight or above a radiator.</li><li>• Caution should be exercised if the room temperature is higher than 36°C (97°F). The air flow for breathing produced by the Vivo 3 can be as much as 4°C (7°F) higher than the ambient room temperature.</li></ul>
<b>Extended Operation Temperature</b>	-20°C to +5°C
	<p>The Vivo 3 is operational during the extended operation temperature for 4 hours, if:</p> <ul style="list-style-type: none"><li>• The Vivo 3 is first started within the normal operation temperature span.</li><li>• The Vivo 3 is placed in its protective cover.</li><li>• This condition happens maximum once a day.</li><li>• The ambient air is dry and still.</li></ul>
<b>Transport and Storage Temperature</b>	<ul style="list-style-type: none"><li>• +5°C to +45°C (Maximum 90 days)</li><li>• -25°C to +70°C (Maximum 30 days)</li></ul>
	<ul style="list-style-type: none"><li>• When the ventilator is brought from minimum/maximum allowed storage temperature, ensure that it is warmed up/cooled down for one hour before starting it.</li><li>• The Vivo 3 must not be stored in a warm place, such as direct sunlight or close to a radiator. If stored in temperatures outside normal operation conditions, let the Vivo 3 acclimate before taking it to use.</li></ul>
<b>Humidity</b>	RH from 15% to 95%, non-condensing.
<b>Ambient Pressure Range</b>	70 to 106 kPa This corresponds to ~ 315 m below sea level to ~3000 m above sea level

Environmental Condition	Specification
<b>Ventilator ingress protection</b>	<p>IP 22</p> <p>Mechanical ingress protection: protected from touch by fingers and objects greater than 12.5 mm</p> <p>Liquid ingress protection: The device withstands dripping water(equivalent to 3 mm rainfall /minute) when not tilted more than 15 degrees from vertical. The protection has been tested for 10 minutes (2.5 minutes in every tilt direction).</p> <p>Mechanical ingress protection: protected from touch by fingers and objects greater than 12.5 mm</p> <p>Liquid ingress protection: The device withstands dripping water(equivalent to 3 mm rainfall /minute) when not tilted more than 15 degrees from vertical. The protection has been tested for 10 minutes (2.5 minutes in every tilt direction).</p> <p><b>Precaution</b></p> <ul style="list-style-type: none"> <li>• There is a silicone lid to protect the USB, SD card, and communication ports. The IP22 classification is applicable only when this lid is in place. However, the accessory box can be connected with retained IP22 classification, but then only the lower part of the silicone lid can be opened.</li> <li>• Ensure that the silicone lid on the back of the ventilator is closed when no accessories are connected.</li> </ul>

## 9.4 Emission and Immunity Declaration

The essential performance listed below has been tested according to applicable parts of IEC 60601-1-2.

### Vivo 3 Essential Performance

The ventilator will deliver ventilation at the patient-connection port within its published accuracy specifications and within the alarm limits set by the operator, or generate any of the following alarms:

- High pressure
- Low pressure
- Low inspired minute volume
- High inspired minute volume
- Low breath rate
- High leakage
- Low last power source
- Power failure
- Disconnection
- High EPAP
- Low EPAP

The ventilator will provide SpO<sub>2</sub> and pulse rate values within its published accuracy specifications and generate an alarm upon a low SpO<sub>2</sub> condition. The ventilator will provide indication when the SpO<sub>2</sub> value or pulse rate is potentially incorrect, and generate an alarm condition to indicate when the SpO<sub>2</sub> value update period has exceeded 30 seconds.

Under the immunity test conditions, the following allowances are acceptable:

- Temporary degradation of performance that does not adversely affect basic safety or essential performance.
- Any temporary degradation of SpO<sub>2</sub> performance following transient immunity test exposure shall recover from any disruption within 30 seconds.

Additionally, the following shall not be allowed:

- permanent damage or unrecoverable loss of function
- changes in programmable parameters or settings
- reset to default settings
- change of operating mode
- initiation of unintended operation
- negative false alarm condition

## 9.4.1

### Guidance and Manufacturer's Declaration – Electromagnetic Immunity

The ventilator is intended for use in the electromagnetic environment specified below. The customer or the user of the ventilator should assure that it is used in such an environment.

Immunity test	Compliance level	Electromagnetic environment — Guidance
Electrostatic discharge (ESD) IEC 61000-4-2	$\pm 8$ kV contact $\pm 15$ kV air	The relative humidity should be at least 5%.
Electrical fast transient/burst IEC 61000-4-4	$\pm 2$ kV for power supply lines $\pm 1$ kV for input/output lines	Mains power quality should be that of a typical commercial, hospital and residential environment.
Surge IEC 61000-4-5	$\pm 0.5$ , $\pm 1$ kV, $\pm 2$ kV line to line	Mains power quality should be that of a typical commercial, hospital and residential environment.
Power frequency (50/60 Hz) magnetic field IEC 61000-4-8	30 A/m	Power frequency magnetic fields should be at levels characteristic of a typical location in a typical commercial, hospital and residential environment.
Voltage dips, short interruptions and voltage variations on power supply input lines IEC 61000-4-11	0% $U_T$ , 0.5 cycle (multiple phase analysis); 0% $U_T$ , 1 cycle; 70% $U_T$ , 25/30 cycles (50/60 Hz); 0% $U_T$ , 250/300 cycles (50/60 Hz);	The ventilator runs on internal battery during voltage dips, short interruptions and voltage variations on power supply input lines.
Proximity Magnetic Fields IEC 61000-4-39	30 kHz: 8 A/m 134.2 kHz: 65 A/m 13.56 MHz: 7.5 A/m	Proximity magnetic fields should be at levels characteristic of a typical location in a typical commercial, hospital, and residential environment.

#### NOTE

$U_T$  is the mains voltage prior to application of the test level.

#### WARNING!

Portable RF communications equipment (including peripherals such as antenna cables and external antennas) should be used no closer than 30 cm (12 inches) to any part of the ventilator, including specified cables. Otherwise, degradation of the performance of this equipment could result.





Immunity test	IEC 60601 test level	Recommended separation distance
Conducted RF IEC 61000-4-6	3 V <sub>rms</sub> (6 V <sub>rms</sub> inside ISM/ASR bands)	$d=0.35*\sqrt{P}$ m at 150 kHz to 80 MHz
Radiated RF IEC 61000-4-3	10 V/m 80 MHz to 2.7 GHz	$d= 1.2*\sqrt{P}$ m at 80 MHz to 800 MHz $d= 2.3*\sqrt{P}$ m at 800 MHz to 2.7 GHz <b>Equation description:</b> P is the maximum output power rating of the transmitter in watts (W) according to the transmitter manufacturer and d is the recommended separation distance in metres (m). Field strengths from fixed RF transmitters, as determined by an electromagnetic site survey <sup>a</sup> , should be less than the compliance level in each frequency range <sup>b</sup> . Interference may occur in the vicinity of equipment marked with this symbol.

- At 80 MHz and 800 MHz, the higher frequency range applies.
  - These guidelines may not apply in all situations. Electromagnetic propagation is affected by absorption and reflection from structures, objects and people.
- a) Field strengths from fixed transmitters, such as base stations for radio (cellular/cordless) telephones and land mobile radios, amateur radio, AM and FM radio broadcast and TV broadcast cannot be predicted theoretically with accuracy. To assess the electromagnetic environment due to fixed RF transmitters, an electromagnetic site survey should be considered. If the measured field strength in the location in which the ventilator is used exceeds the applicable RF compliance level above, the ventilator should be observed to verify normal operation. If abnormal performance is observed, additional measures may be necessary, such as reorienting or relocating the ventilator.
- b) Over the frequency range 150 kHz to 80 MHz, field strengths should be less than 10 V/m.

### Proximity fields from RF wireless communications equipment

Frequency Range and Level: RF wireless communication equipment		
Test Frequency (MHz)	Modulation*	Immunity Level (V/m)
385	Pulse Modulation: 18 Hz	27
450	Pulse Modulation: 18 Hz	28
710 745 780	Pulse Modulation: 217 Hz	9
810 870 930	Pulse Modulation: 18 Hz	28
1720 1845 1970	Pulse Modulation: 217 Hz	28
* The carrier shall be modulated using a 50 % duty cycle square wave signal.		

Frequency Range and Level: RF wireless communication equipment		
Test Frequency (MHz)	Modulation*	Immunity Level (V/m)
2450	Pulse Modulation: 217 Hz	28
5240 5500 5785	Pulse Modulation: 217 Hz	9
* The carrier shall be modulated using a 50 % duty cycle square wave signal.		

### 9.4.2 Guidance and Manufacturer's Declaration – Electromagnetic Emission

The ventilator is intended for use in the electromagnetic environment specified below. The customer or the user of the ventilator should assure that it is used in such an environment.

Immunity test	Compliance	Electromagnetic environment – Guidance
RF emissions CISPR 11	Group 1	The ventilator uses RF energy only for its internal function. Therefore, its RF emissions are very low and are not likely to cause any interference in nearby electronic equipment.
RF emissions CISPR 11	Class B	The ventilator is suitable for use in all establishments, including domestic establishments and those directly connected to the public low-voltage power supply network that supplies buildings used for domestic purposes.
Harmonic emissions IEC 61000-3-2	Class A	
Voltage fluctuations/flicker emission IEC 61000-3-3	Complies	

### 9.4.3 Recommended separation distances between portable and mobile RF communications equipment and the ventilator

The ventilator is intended for use in an electromagnetic environment in which radiated RF disturbances are controlled. The customer or the user of the ventilator can help prevent electromagnetic interference by maintaining a minimum distance between portable and mobile RF communications equipment (transmitters) and the ventilator as recommended below, according to the maximum output power of the communications equipment.

Rated maximum output power of transmitter (W)	Separation distance according to the frequency of transmitter (m)		
	150 kHz to 80 MHz $d = 0.35 \cdot \sqrt{P}$ m	80 MHz to 800 MHz $d = 1.2 \cdot \sqrt{P}$ m	800 MHz to 2.7 GHz $d = 2.3 \cdot \sqrt{P}$ m
0.01	0.035	0.12	0.23
0.1	0.11	0.38	0.73
1	0.35	1.20	2.3
10	1.1	3.8	7.3
100	3.5	12.0	23

For transmitters rated at a maximum output power not listed above, the recommended separation distance  $d$  in metres (m) can be estimated using the equation applicable to the frequency of the transmitter, where  $P$  is the maximum output power rating of the transmitter in watts (W) according to the transmitter manufacturer.

**Notes**

- At 80 MHz and 800 MHz, the separation distance for the higher frequency range applies.
- These guidelines may not apply in all situations. Electromagnetic propagation is affected by absorption and reflection from structures, objects and people.

**9.4.4**

**Recommended separation distances between external power conductors and the ventilator**

Rated maximum current in conductor (A)	Separation distance (m)
	50-60 Hz: $d = I/2\pi H = I/188$
1	0.005
10	0.05
30	0.16

For conductors rated at a maximum current not listed above, the recommended separation distance  $d$  in meters (m) can be estimated using the equation  $d = I/2\pi H$ , where  $I$  is the maximum current rating of the conductor in amperes (A) according to the transmitter manufacturer;  $H$  is the ventilator immunity compliance level to electromagnetic fields in the 50-60 Hz frequency span (30 A/m).

# 10

## Accessories

The accessories described in this section, together with the *medical electric equipment* defined in chapter 3.1 *Overview*, page 22, constitute the Vivo 3 *medical electric system*. Accessory information can also be found at <http://www.breas.com>.

### CAUTION!

#### Responsibility for System

Accessory equipment connected to the analogue and digital interfaces must be certified according to the respective IEC standards (e.g. IEC 60950 or IEC 62368 for data processing equipment and IEC 60601-1 for medical equipment). Furthermore all configurations must comply with the valid version of the system standard IEC 60601-1. Anybody who connects additional equipment to the signal input part or signal output part is configuring a medical system, and is therefore responsible for ensuring that the system complies with the requirements of the valid version of the system standard IEC 60601-1. If in doubt, consult the technical service department or your local representative.

A PC, when connected to the ventilator, shall comply with IEC 62368-1, IEC 60950-1 or IEC 60601-1.



### 10.1

#### Patient Circuits and Air Delivery Accessories

**Circuit: Single limb 22 mm. Single patient multiple use.**

**Function:** Delivers air to the patient, applied part

**Part No:** 008426 (30-pack of 004465)

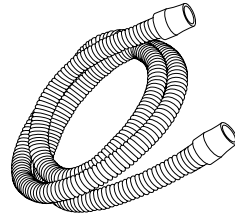

**Circuit: Single limb 15 mm. Single patient multiple use.**

**Function:** Delivers air to the patient, applied part

**Part No:** 008427 (30-pack of 006712)

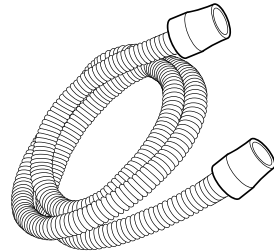

## Heated Circuit

**Function:** Delivers air to the patient, applied part.  
Prevents rain-out.

**Part No:** 006990

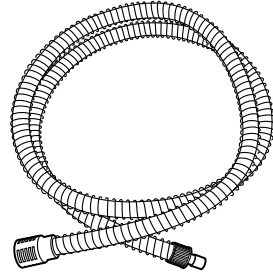

## Leakage Port

**Function:** Providing a leakage for clearing exhaled gases. Disposable.

**Part No:** 007243 (10 pieces)

## Low resistance bacterial filter, with CO<sub>2</sub> connector

**Function:** Filter air at ventilator outlet

### Characteristics

- Resistance:
  - 0.5 cmH<sub>2</sub>O @ 30 l/m
  - 1.4 cmH<sub>2</sub>O @ 60 l/m
  - 2.76 cmH<sub>2</sub>O @ 90 l/m
- Deadspace: 33 ml
- BFE (Bacterial Filtration Efficiency): 99.9999%
- VFE (Viral Filtration Efficiency): 99.999 %

**Part No:** 007963

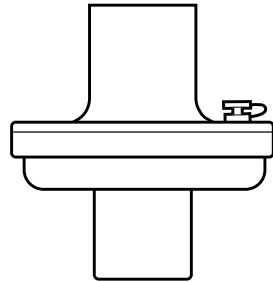

## 10.2 Power Accessories

### DC/DC Power Supply (RRC CAR 70M)

**Function:** Power supply adapter for the ventilator. Shall be used when connecting to an external DC source. Compliant with IEC 60601-1.

**Part No:** 006995

### Y Cable

**Function:** Power supply cable, for connecting to both AC and DC power supply.

**Part No:** 007006

## 10.3 Ventilator Filters and Detachable Parts

### Attachable humidifier

**Function:** Humidifies the patient air. For non-invasive use only.

**Part No:** 006977

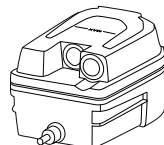

### Air Inlet Filter, Grey

**Function:** Coarse air inlet filter, user replaceable part. Long life (washable).

**Part No:** 007203 (5 pieces)

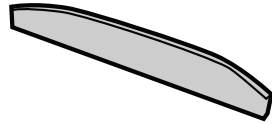

### Air Inlet Filter, White

**Function:** Fine air inlet filter, user replaceable part. Disposable.

**Part No:** 007202 (5 pieces)



## 10.4 Monitoring Accessories

### Accessory Box

**Function:** For connecting measurement and communication accessories:

- Nurse call cable or Remote alarm
- SpO<sub>2</sub> sensor (Might also be connected directly to the Vivo 3, if no other measurement or communication accessories are used.)

**Part No:** 007000

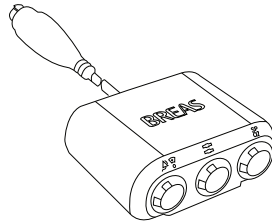

### Remote alarm with cable

**Function:** Monitor Vivo 3 alarms remotely

**Part No:** 10 m: 006348, 25 m: 006349

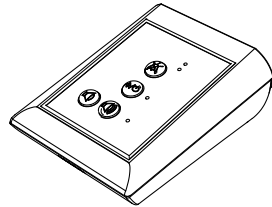

### Nurse call cable

**Function:** Connect the ventilator to a hospital nurse call system

**Part No:**

NO: 006365

NC: 006364

10 k $\Omega$ , NO: 006363

10 k $\Omega$ , NC: 006362

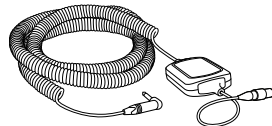

### Masimo SpO<sub>2</sub> Module

**Function:** Connection interface

**Part No:** 006369

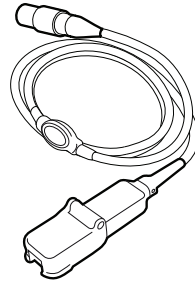

### Masimo SpO<sub>2</sub> sensor

**Function:** Finger Clip SpO<sub>2</sub> sensor

**Part No:**

Adult: 006589

Paediatric: 006590

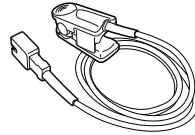

### SpO<sub>2</sub> sensor

**Function:** Multisite SpO<sub>2</sub> sensor

**Part No:** 006591

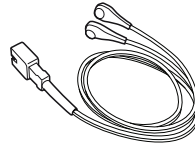

### SpO<sub>2</sub> Adapter Cable

**Function:** Connection cable. For use of SpO<sub>2</sub> without accessory box.

**Part No:** 007079

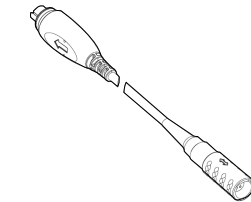

### PC Software

**Function:** Support software for follow-up on patient treatment.

**Part No:** 007067

### USB Cable

**Function:** USB cable for transferring data between a PC and the Vivo 3.

**Part No:** 005757

### Memory card

**Function:** Storage and transfer of settings, patient data and usage data

**Part No:** 006705

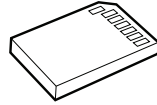

### Memory card reader/writer

**Function:** Read/write memory card

**Part No:** 002185

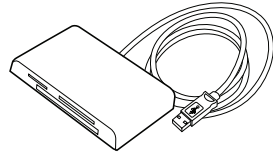

## 10.5 Other Accessories

### Protective Cover

**Function:** Shock protection

**Part No:** 007014

### Lightweight Mobility Bag

**Function:** For mobile use of the Vivo 3 in hospital, institutions and home care environments.

**Part No:** 007380

### Trolley

**Function:** Mobile use, transportation

**Part No:** 007384

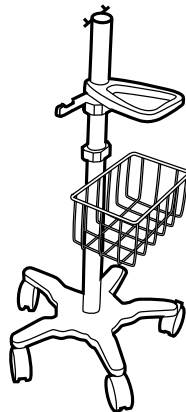



### Mounting Bracket

**Function:** Bracket to mount the Vivo 3 to the trolley

**Part No:** 006998

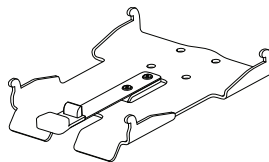

### Universal rail clamp

**Function:** Attach a humidifier to a trolley.

**Part No:** 007858

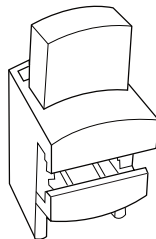



# Appendix



# Index

## A

AC Voltage supply	74
Accessories	82
using	44
Air outlet	23
Alarm	30
Ambient Pressure Compensation	
Lost	68
Apnea	62
Circuit	65
Critically Low Battery. Connect to	
Mains	68
Disconnection	62, 65
Flow sensor failure	69
High breath rate	60
High EPAP	63
High minute volume	61
High Patient Air Temp (High Patient Air Temperature)	69
High pressure	59
High pressure limitation	66
High pulse rate	64
High SpO <sub>2</sub>	64
Internal Function Failure	70
Low Battery	68
Low breath rate	60
Low EPAP	63
Low minute volume	61
Low pressure	59
Low pulse rate	65
Low SpO <sub>2</sub>	64
Power Failure Alarm	66
Rebreathing	62
resetting	56
SpO <sub>2</sub> artifact	67
SpO <sub>2</sub> sensor failure / disconnected	67
Alarm condition	
identifying	55
Alarm message	56
Alarm signal	
Check	39
LED	56
Alarm sound	
pausing	56
Alarm time	30

Alarm volume	30
Alarms	54
physiological	58
Ambient Pressure Compensation Lost alarm	68
Apnea alarm	62
Average usage hours	31

## B

Battery	23
Battery percentage	30
Battery time left	30
Battery,(internal) specifications	74
Blocked Circuit	65
Board revision	30
Bootloader version	30
Buttons	22

## C

Caution	
Icon	8
Check	
Compliance and resistance	39
Start-up	39
Circuit Disconnection	65
Cleaning	18, 71
Clock	30
Command	
execute	26
Communication port	23
Compliance	
Check	39
Contraindications	7
Critically Low Battery. Connect to Mains alarm	68

## D

Date	30
Date format	30
Days with usage	31
DC Voltage	
supply	74
Device information	30
Device memory	30
Device settings	29
Disconnection alarm	62

Display .....	22
Display light.....	29

## E

Electromagnetic compatibility.....	13
Electromagnetic emission .....	80
Electromagnetic immunity .....	78
Electrostatic discharge.....	13
Environmental conditions.....	75
Erase memory data .....	30

## F

Filter	
usage.....	16
Filters	
clean, replace .....	72
Firmware version .....	30
Front panel.....	22

## H

Heated circuit	
setting .....	36
using.....	47
Heating.....	17
High breath rate alarm.....	60
High EPAP alarm.....	63
High Patient Air Temperature	
Alarm (High Patient Air	
Temp) alarm.....	69
High pressure alarm .....	59
High pulse rate alarm.....	64
High SpO <sub>2</sub> alarm.....	64
Humidification.....	17
Humidifier	
setting .....	35
Humidifier, attachable	
using.....	44
Hypoventilation.....	60

## I

Icon	
Caution.....	8
Note.....	8
Reference.....	8
Warning .....	8
Interface board revision .....	30
Internal Function Failure alarm .....	70

Invasive use .....	17
--------------------	----

## L

Languages .....	29
Leakage	
Check.....	39
Light intensity.....	29
Low Battery alarm .....	68
Low breath rate alarm .....	60
Low EPAP alarm .....	63
Low pressure alarm.....	59
Low pulse rate .....	65
Low SpO <sub>2</sub> alarm .....	64

## M

Maintenance .....	18, 71
Memory card port .....	23
Memory data .....	30
Menus .....	24
Min daily use .....	31
Mobile use	
safety .....	21
Monitor treatment .....	43

## N

Note	
Icon.....	8
Nurse call connection	
using.....	50

## O

Operating conditions .....	75
Oxygen	
usage.....	20
Oxygen concentration .....	20

## P

Patient air outlet .....	23
Patient circuit	
connect .....	38
Placing .....	37
Power Failure Alarm alarm .....	66
Power handling	
Check.....	39
Power management.....	23
Power port .....	23

Power supply	
connect.....	37
Pre-use test.....	39
Pre-Use Test	
Failure.....	40
Pressure unit.....	29
Product name.....	30
Protective cover.....	51

## R

Ramp down.....	35
Ramp up.....	35
Rebreathing alarm.....	62
Reference	
Icon.....	8
Remote alarm unit	
using.....	50
Reset compliance data.....	31
Resistance	
Check.....	39
RF communications equipment.....	80

## S

Save memory data on card.....	30
SD card port.....	23
Settings.....	35
change.....	26
Setup pages.....	28
Sound level, alarm.....	58
SpO <sub>2</sub> sensor	
using.....	48
Start date.....	31
Stop the treatment.....	42
Switch off.....	43
Switch on.....	41
Symbols.....	31

## T

Technical specifications.....	74
Time.....	30
Time format.....	30
Total days.....	31
Total usage hours.....	31
Transit operation	
safety.....	21
Treatment	
start.....	41
Treatment data.....	27

## U

Undesirable side effects.....	7
Usage time	
Internal battery.....	74
USB port.....	23
Using instructions.....	41

## V

Voltage	
supply.....	74

## W

Warning	
Icon.....	8
Wheel chair	
safety.....	21

## Y

Y-cable.....	51
--------------	----